

TOLEDO®

LOCKS • PADLOCKS • HARDWARE



TOLEDO®

Toledo & Co., LLC is an international company founded in 2003, specializing in the sale and export of high-quality security products such as locks, padlocks, and hardware for residential and commercial spaces. We collaborate with various department store chains and hardware stores to distribute our products, renowned for their innovation and durability.

With over 60,000 square feet of storage space, we continue to expand our infrastructure to meet growing demand. Our distribution centers are strategically located in Puerto Rico, Panama, the Dominican Republic, Florida, and Massachusetts, enabling us to serve more than 40 countries across the Caribbean, South America, Central America, and the United States.

VISION

To be globally recognized as a strong and leading brand in high-quality, innovative security products at fair prices.

MISSION

To foster an organizational culture without territorial boundaries, delivering on our promise of genuine excellence and staying at the forefront of technology in our processes and products. We also cultivate close relationships with our customers to ensure 100% satisfaction and achieve our goals successfully.

VALUES

- Commitment
- Quality and excellence in service
- Personalized service and close customer relationships

Toledo & Co. is recognized within the industry for keeping its promises, maintaining personal contact with customers, and offering fair prices.

SLOGAN

Protection in Steel and Bronze. Our Guarantee: A Lifetime Warranty.



Table of Contents

Fine Locks

Knobs	5-9
Levers	10-14
Deadbolts	15-17
COMBOSs	18-21
Handlesets	22-25

European

Knobs	26-27
Levers	28-30
Deadbolts	31-33
COMBOSs	34-35

Electronic

NEXUS	36-39
Electronic Doorlocks	40-46

Platinum

47-49

Commercial

50-53

Barn Door Hardware

54-56

Solid Stainless Steel

57-63

Mortise Locks Black Series	64
----------------------------------	----

Gate Locks

65-67

Padlocks

68-76

Black Series	77-82
--------------------	-------

Window Hardware

83-92

Hardware	93-116
Tension Hardware	117-120
Ropes	121-125
Hardware	126-132
Fence Hardware	133-139
Mailboxes and Security Boxes	140-141

T-Locks

142

Deadbolts, Knobs, and Handles	143-145
COMBOSs	146-147
Handle Sets	148
Padlocks	149
Hardware	150-151

Toledo & Co. Distribution

153

Toledo Store Fixtures

154-157

T-Locks Store Fixtures	158
------------------------------	-----

Toledo Finishes & Product Item Number Diagram

V1900-MA-US32D = *Málaga entry knob in satin stainless steel finish.*

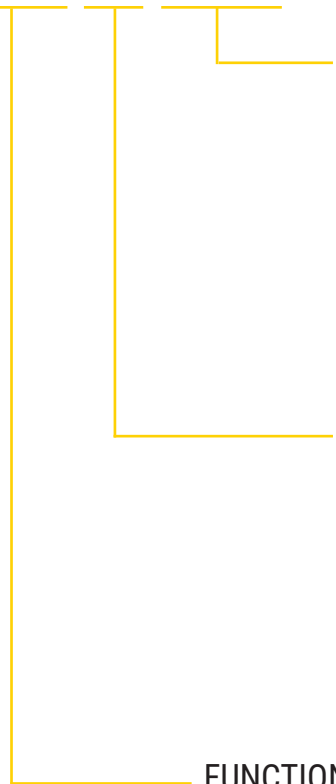

FINISH

-  **US26**
Polished Chrome Plated
-  **US26D**
Satin Chrome
-  **US32**
Polished Stainless Steel

-  **US32D**
Satin Stainless Steel
-  **US3**
Polished Brass
-  **US4**
Satin Brass
-  **US5**
Antique Brass

-  **US11**
Antique Copper
-  **US15**
Satin Nickel Plated
-  **US15A**
Antique Satin Nickel
-  **US514**
Iron Black

MODEL

- | | | |
|------------------|------------------|-----------------|
| - Málaga (MA) | - Itálica (IT) | - Vigo (VI) |
| - Ávila (AV) | - Tarragona (TA) | - Lugo (LU) |
| - Jaén (JA) | - Córdoba (CO) | - Girona (GI) |
| - Segovia (SE) | - Alicante (AL) | - Mérida (ME) |
| - Bilbao (BI) | - Oviedo (OV) | - Hispania (HI) |
| - Barcelona (BA) | - Granada (GR) | - Zaragoza (ZA) |
| - León (LE) | - Tenerife (TE) | - Valencia (VA) |

- DEADBOLTS ---
- Square (SQR)
 - Low Profile (LP)

FUNCTION

- | | | |
|--|--|--|
|  Entrance (1900, 1930, 1500, 1501, 1600 y 1601) |  Storeroom (1940) |  Single (1800) |
|  Privacy (1920 y 1950) |  Classroom (1960) |  Double (1801) |
|  Hall / Closet (1910) |  Double Cylinder (1980) |  One Sided (1805) |

--- DEADBOLTS ---

Fine Locks **KNOBS**

The Fine Locks line by Toledo offers an extensive variety of models, finishes, and functions designed to suit different styles and needs at home. With certified options and a lifetime warranty, these locks combine style and reliability to provide security solutions that inspire confidence.



Málaga Knob - Exterior / Interior Lock

**KEYED ENTRY****CV1900MAUS3**

UPC: 871193000029

MC-6 / V-6

V1900MAUS5

UPC: 871193000036

MC-10 / V-5

V1900MAUS11

UPC: 871193004461

MC-10 / V-5

V1900MAUS32

UPC: 871193000005

MC-10 / V-5

V1900MAUS32D

UPC: 871193000012

MC-10 / V-5

V1900MAUS514

UPC: 810055043736

MC-10/ V-5

PRIVACY**CV1920MAUS3**

UPC: 871193000067

MC-6 / V-6

V1920MAUS5

UPC: 871193000074

MC-10 / V-5

V1920MAUS11

UPC: 871193004478

MC-10 / V-5

V1920MAUS32

UPC: 871193000043

MC-10 / V-5

V1920MAUS32D

UPC: 871193000050

MC-10 / V-5

V1920MAUS514

UPC: 810055043743

MC-10 / V-5

HALL / CLOSET**CV1910MAUS32D**

UPC: 871193006908

MC-1 / V-6

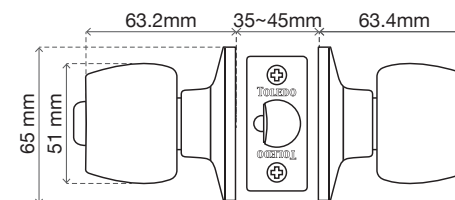
**FEATURES:**

- Impact-resistant cylinder in keyed entry locks for greater security.
- Universal latch: Adjustable from 2 3/8" to 2 3/4" (60mm - 70mm).
- Door thickness: Compatible with standard thicknesses from 1 3/8" to 1 3/4" (35mm - 45mm).
- Bore hole depth: Adapts to configurations from 2 3/8" to 2 3/4" (60mm - 70mm).
- Faceplate: Standard square corner of 1" x 2 1/4" (25.4mm x 57mm).
- Deadbolt: Made of zinc alloy with a 1/2" nickel-plated bolt for added durability.
- Strike plate: Square corner with dimensions of 1 3/4" x 2 1/4" (44.4mm x 57mm).
- Standard 5-pin Y1 cylinder for secure operation.

CERTIFICATIONS:

- **ANSI/BHMA A156.2 2011/2017 - Grade 3**
- Complies with 30-minute fire resistance certification UL File No. R13776.



KNOBSET

Fine Locks®

US32 US3 US5 US32D US15 US15A US11 US514



Ávila Knob - Exterior / Interior Lock

KEYED ENTRY

CV1900AVUS3

UPC: 871193000470

MC-6 / V-6

V1900AVUS5

UPC: 871193000487

MC-10 / V-5

V1900AVUS32D

UPC: 871193000463

MC-10 / V-5

PRIVACY

CV1920AVUS3

UPC: 871193000500

MC-6 / V-6

V1920AVUS5

UPC: 871193000517

MC-10 / V-5

V1920AVUS32D

UPC: 871193000494

MC-10 / V-5

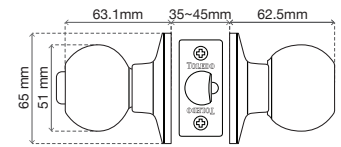

HALL / CLOSET

V1910AVUS32D

UPC: 871193001170

MC-10 / V-5

FEATURES:

- Impact-resistant cylinder for greater security.
- Adjustable latch from 2 3/8" to 2 3/4" (60mm - 70mm).
- Compatible with doors from 1 3/8" to 1 3/4" (35mm - 45mm).
- Adaptable bore hole depth from 2 3/8" to 2 3/4" (60mm - 70mm).
- Standard square corner faceplate of 1" x 2 1/4" (25.4mm x 57mm).
- Zinc alloy deadbolt with 1/2" nickel-plated bolt.
- Square corner strike plate of 1 3/4" x 2 1/4" (44.4mm x 57mm).
- Standard 5-pin Y1 cylinder.

CERTIFICATIONS:

- ANSI/BHMA A156.2 2011/2017 - Grado 3.
- Cumple con el certificado de resistencia al fuego de 30 mins. Expediente UL No. R13776



Santiago Knob - Exterior / Interior Lock

KEYED ENTRY

V1900SAUS15

UPC: 871193002597

MC-10 / V-5

V1900SAUS514

UPC: 871193004669

MC-10 / V-5

PRIVACY

V1920SAUS5

UPC: 871193003235

MC-10 / V-5

V1920SAUS15

UPC: 871193002603

MC-10 / V-5

V1920SAUS514

UPC: 871193001460

MC-10 / V-5

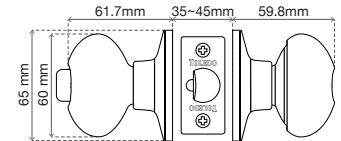

FEATURES:

- Keyed entry locks features an anti-bump cylinder for enhanced security.
- Adjustable Latch: Fits backsets from 2 3/8" to 2 3/4" (60mm - 70mm).
- Door Compatibility: Fits doors with thicknesses of 1 3/8" to 1 3/4" (35mm - 45mm).
- Adaptable Bore Hole Depth: Works with depths of 2 3/8" to 2 3/4" (60mm - 70mm).
- Standard Square Corner Faceplate: Dimensions of 1" x 2 1/4" (25.4mm x 57mm).
- Zinc Alloy Deadbolt: Features a 1/2" nickel-plated bolt for durability.
- Square Corner Strike Plate: Measures 1 3/4" x 2 1/4" (44.4mm x 57mm).
- 5-Pin Y1 Cylinder: Standard configuration for secure operation.

CERTIFICATIONS:

- ANSI/BHMA A156.2 2011/2017 - Grado 3.
- Cumple con el certificado de resistencia al fuego de 30 mins. Expediente UL No. R13776



Ávila Knob - Cylindrical Exterior Lock

KEYED ENTRY

V1930AVUS32D

Push Button

UPC: 871193002320

MC-10 / V-5

FEATURES:

- Keyed entry lock.
- Suitable for all standard distances between the knob and the edge of the door, both wood and metal, from 1 3/8 to 1 3/4 inches thick (35mm to 45mm).
- Exceeds industry standards in durability tests.
- Easy to install or replace.
- Impact-resistant cylinder for greater security.
- Adjustable latch from 2 3/8" to 2 3/4" (60mm - 70mm).
- Compatible with doors from 1 3/8" to 1 3/4" (35mm - 45mm).
- Adaptable bore hole depth from 2 3/8" to 2 3/4" (60mm - 70mm).
- Standard square corner faceplate of 1" x 2 1/4" (25.4mm x 57mm).
- Zinc alloy deadbolt with 1/2" nickel-plated bolt.
- Square corner strike plate of 1 3/4" x 2 1/4" (44.4mm x 57mm).
- Standard 5-pin Y1 cylinder.

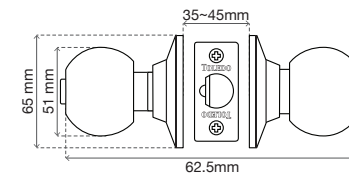

CERTIFICATIONS:

- ANSI/BHMA A156.2 2011/2017 - Grade 3
- Complies with 30-minute fire resistance certification UL File No. R13776.



Ávila Knob - Cylindrical Exterior Lock

STORAGE ROOM

V1940AVUS32D

UPC: 871193001262

MC-10 / V-5

FEATURES:

- Keyed entry lock.
- Suitable for all standard distances between the knob and the edge of the door, both wood and metal, from 1 3/8 to 1 3/4 inches thick (35mm to 45mm).
- Exceeds industry standards in durability tests.
- Easy to install or replace.
- Impact-resistant cylinder for greater security.
- Adjustable latch from 2 3/8" to 2 3/4" (60mm - 70mm).
- Compatible with doors from 1 3/8" to 1 3/4" (35mm - 45mm).
- Adaptable bore hole depth from 2 3/8" to 2 3/4" (60mm - 70mm).
- Standard square corner faceplate of 1" x 2 1/4" (25.4mm x 57mm).
- Zinc alloy deadbolt with 1/2" nickel-plated bolt.
- Square corner strike plate of 1 3/4" x 2 1/4" (44.4mm x 57mm).
- Standard 5-pin Y1 cylinder.

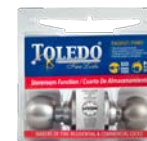
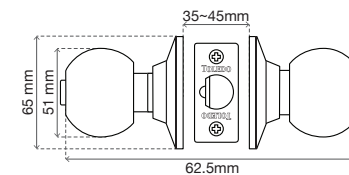

CERTIFICATIONS:

- ANSI/BHMA A156.2 2011/2017 - Grade 3
- Complies with 30-minute fire resistance certification UL File No. R13776.



US32 US3 US5 US32D US15 US15A US11 US514



Ávila Knob - Cylindrical Interior Lock

PRIVACY

V1950AVUS32D

Push Button

UPC: 871193002337

MC-10 / V-5

FEATURES:

- Interior lock for bedroom and bathroom.
- Suitable for all standard distances between the knob and the edge of the door, both wood and metal, from 1 3/8" to 1 3/4" inches thick (35mm to 45mm).
- Exceeds industry standards in durability tests.
- Easy to install or replace.
- Impact-resistant cylinder for greater security.
- Adjustable latch from 2 3/8" to 2 3/4" (60mm - 70mm).
- Compatible with doors from 1 3/8" to 1 3/4" (35mm - 45mm).
- Adaptable bore hole depth from 2 3/8" to 2 3/4" (60mm - 70mm).
- Standard square corner faceplate of 1" x 2 1/4" (25.4mm x 57mm).
- Zinc alloy deadbolt with 1/2" nickel-plated bolt.
- Square corner strike plate of 1 3/4" x 2 1/4" (44.4mm x 57mm).
- Standard 5-pin Y1 cylinder.

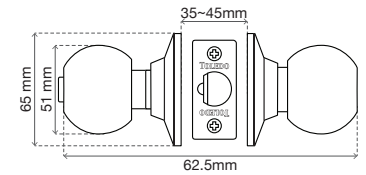

CERTIFICATIONS:

- ANSI/BHMA A156.2 2011/2017 - Grade 3
- Complies with 30-minute fire resistance certification UL File No. R13776.



Ávila Knob - Cylindrical Exterior Lock

DOUBLE CYLINDER

V1980AVUS32D

Key on Both Sides

UPC: 871193001279

MC-10 / V-5

FEATURES:

- Keyed entry lock.
- Suitable for all standard distances between the knob and the edge of the door, both wood and metal, from 1 3/8" to 1 3/4" inches thick (35mm to 45mm).
- Exceeds industry standards in durability tests.
- Easy to install or replace.
- Impact-resistant cylinder for greater security.
- Adjustable latch from 2 3/8" to 2 3/4" (60mm - 70mm).
- Compatible with doors from 1 3/8" to 1 3/4" (35mm - 45mm).
- Adaptable bore hole depth from 2 3/8" to 2 3/4" (60mm - 70mm).
- Standard square corner faceplate of 1" x 2 1/4" (25.4mm x 57mm).
- Zinc alloy deadbolt with 1/2" nickel-plated bolt.
- Square corner strike plate of 1 3/4" x 2 1/4" (44.4mm x 57mm).
- Standard 5-pin Y1 cylinder.

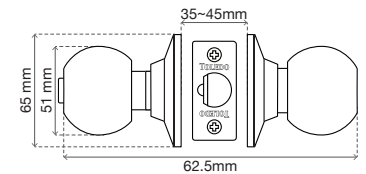

CERTIFICATIONS:

- ANSI/BHMA A156.2 2011/2017 - Grade 3
- Complies with 30-minute fire resistance certification UL File No. R13776.



KNOBSET



Fine Locks®

Fine Locks
LEVERS





Jaén Handle - Exterior / Interior Lock

KEYED ENTRY

V1900JAUS5

UPC: 871193003129

MC-10 / V-5

V1900JAUS11

UPC: 871193004522

MC-10 / V-5

V1900JAUS15

UPC: 871193003105

MC-10 / V-5

CV1900JAUS15A

UPC: 871193003112

MC-6 / V-6

V1900JAUS514

UPC: 871193007097

MC-10 / V-5

PRIVACY

V1920JAUS5

UPC: 871193003150

MC-10 / V-5

CV1920JAUS11

UPC: 871193004539

MC-6 / V-6

V1920JAUS15

UPC: 871193003136

MC-10 / V-5

CV1920JAUS15A

UPC: 871193003143

MC-6 / V-8

V1920JAUS514

UPC: 871193007103

MC-10 / V-5

HALL / CLOSET

CV1910JAUS15

UPC: 871193004423

MC-6 / V-6

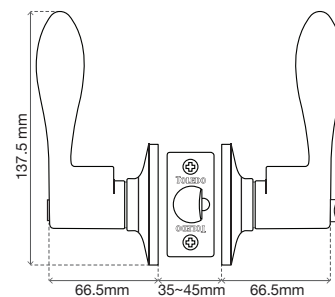

FEATURES:

- Left and Right Function
- Impact-resistant cylinder in keyed entry locks for greater security.
- Universal Latch: Adjustable from 2 3/8" to 2 3/4" (60mm - 70mm) for different door configurations.
- Door Thickness: Compatible with standard thicknesses from 1 3/8" to 1 3/4" (35mm - 45mm).
- Bore Hole Depth: Adapts to configurations of 2 3/8" to 2 3/4" (60mm - 70mm).
- Faceplate: Standard square corner of 1" x 2 1/4" (25.4mm x 57mm).
- Deadbolt: Made of zinc alloy with a 1/2" nickel-plated bolt for added durability.
- Strike Plate: Square corner with dimensions of 1 3/4" x 2 1/4" (44.4mm x 57mm).
- Standard 5-pin Y1 cylinder for secure operation.

CERTIFICATIONS:

- ANSI/BHMA A156.2 2011/2017 - Grade 3
- Complies with 30-minute fire resistance certification UL File No. R13776.



LEVERSET



Fine Locks

Segovia Handle - Exterior / Interior Lock

KEYED ENTRY V1900SEUS5

UPC: 871193000180
MC-10 / V-5

V1900SEUS15
UPC: 871193000166
MC-10 / V-5

HALL / CLOSET
CV1910SEUS15
UPC: 871193002344
MC-6 / V-6

PRIVACY
V1920SEUS5
UPC: 871193000210
MC-10 / V-5

V1920SEUS15
UPC: 871193000197
MC-10 / V-5

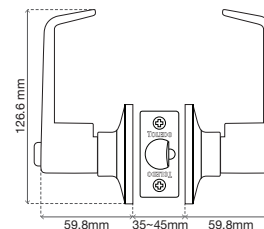

FEATURES:

- Left and Right Function
- Impact-resistant cylinder for greater security.
- Adjustable latch from 2 3/8" to 2 3/4" (60mm - 70mm).
- Compatible with doors from 1 3/8" to 1 3/4" (35mm - 45mm).
- Adaptable bore hole depth from 2 3/8" to 2 3/4" (60mm - 70mm).
- Standard square corner faceplate of 1" x 2 1/4" (25.4mm x 57mm).
- Zinc alloy deadbolt with 1/2" nickel-plated bolt.
- Square corner strike plate of 1 3/4" x 2 1/4" (44.4mm x 57mm).
- Standard 5-pin Y1 cylinder.

CERTIFICATIONS:

- ANSI/BHMA A156.2 2011/2017 - Grade 3
- Complies with 30-minute fire resistance certification UL File No. R13776.



Bilbao Handle - Exterior / Interior Lock

KEYED ENTRY
CV1900BIUS15
UPC: 871193005536
MC-6 / V-6

PRIVACY
CV1920BIUS15
UPC: 871193005543
MC-6 / V-6

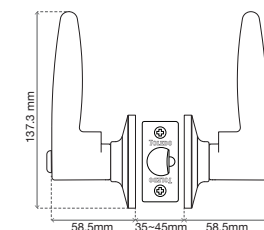

FEATURES:

- Left and Right Function
- Impact-resistant cylinder for greater security.
- Adjustable latch from 2 3/8" to 2 3/4" (60mm - 70mm).
- Compatible with doors from 1 3/8" to 1 3/4" (35mm - 45mm).
- Adaptable bore hole depth from 2 3/8" to 2 3/4" (60mm - 70mm).
- Standard square corner faceplate of 1" x 2 1/4" (25.4mm x 57mm).
- Zinc alloy deadbolt with 1/2" nickel-plated bolt.
- Square corner strike plate of 1 3/4" x 2 1/4" (44.4mm x 57mm).
- Standard 5-pin Y1 cylinder.

CERTIFICATIONS:

- ANSI/BHMA A156.2 2011/2017 - Grade 3
- Complies with 30-minute fire resistance certification UL File No. R13776.



LEVERSET



Fire Locks®

US32 US3 US5 US32D US15 US15A US11 US514



Barcelona Handle - Exterior / Interior Lock

KEYED ENTRY

V1900BAUS5

UPC: 871193003167

MC-10 / V-5

V1900BAUS15

UPC: 871193001118

MC-10 / V-5

CV1900BAUS15A

UPC: 871193003174

MC-6 / V-6

PRIVACY

V1920BAUS5

UPC: 871193003181

MC-10 / V-5

V1920BAUS15

UPC: 871193001125

MC-10 / V-5

CV1920BAUS15A

UPC: 871193003198

MC-6 / V-6

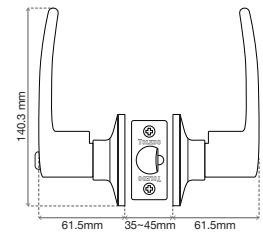

CERTIFICATIONS:

- ANSI/BHMA A156.2 2011/2017 - Grade 3
- Complies with 30-minute fire resistance certification UL File No. R13776.



HALL / CLOSET

CV1910BAUS15

UPC: 871193004416

MC-6 / V-6

FEATURES:

- Left and Right Function
- Impact-resistant cylinder for greater security.
- Adjustable latch from 2 3/8" to 2 3/4" (60mm - 70mm).
- Compatible with doors from 1 3/8" to 1 3/4" (35mm - 45mm).
- Adaptable bore hole depth from 2 3/8" to 2 3/4" (60mm - 70mm).
- Standard square corner faceplate of 1" x 2 1/4" (25.4mm x 57mm).
- Zinc alloy deadbolt with 1/2" nickel-plated bolt.
- Square corner strike plate of 1 3/4" x 2 1/4" (44.4mm x 57mm).
- Standard 5-pin Y1 cylinder.

León Handle - Exterior / Interior Lock

KEYED ENTRY

V1900LEUS15

UPC: 871193004683

MC-10 / V-5

PRIVACY

V1920LEUS15

UPC: 871193004706

MC-10 / V-5

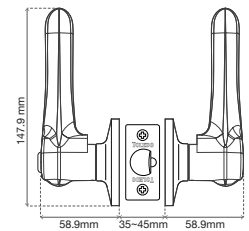

CERTIFICATIONS:

- ANSI/BHMA A156.2 2011/2017 - Grade 3
- Complies with 30-minute fire resistance certification UL File No. R13776.



FEATURES:

- Left and Right Function
- Impact-resistant cylinder for greater security.
- Adjustable latch from 2 3/8" to 2 3/4" (60mm - 70mm).
- Compatible with doors from 1 3/8" to 1 3/4" (35mm - 45mm).
- Adaptable bore hole depth from 2 3/8" to 2 3/4" (60mm - 70mm).
- Standard square corner faceplate of 1" x 2 1/4" (25.4mm x 57mm).
- Zinc alloy deadbolt with 1/2" nickel-plated bolt.
- Square corner strike plate of 1 3/4" x 2 1/4" (44.4mm x 57mm).
- Standard 5-pin Y1 cylinder.

LEVERSET



Fire Locks

Itálica Handle - Exterior / Interior Lock

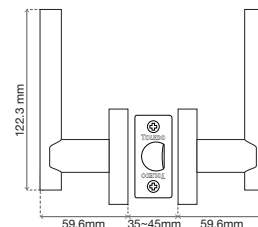

PRIVACY
CV1920ITUS15
 UPC: 871193003099
 MC-6 / V-6

FEATURES:

- Left and Right Function
- Adjustable latch from 2 3/8" to 2 3/4" (60mm - 70mm).
- Compatible with doors from 1 3/8" to 1 3/4" (35mm - 45mm).
- Adaptable bore hole depth from 2 3/8" to 2 3/4" (60mm - 70mm).
- Standard square corner faceplate of 1" x 2 1/4" (25.4mm x 57mm).
- Zinc alloy deadbolt with 1/2" nickel-plated bolt.
- Square corner latch of 1 3/4" x 2 1/4" (44.4mm x 57mm).



Tarragona Handle - Exterior / Interior Lock

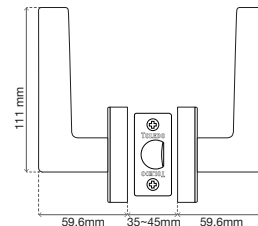

PRIVACY
CV1920TAUS15
 UPC: 871193003082
 MC-6 / V-6

FEATURES:

- Left and Right Function
- Adjustable latch from 2 3/8" to 2 3/4" (60mm - 70mm).
- Compatible with doors from 1 3/8" to 1 3/4" (35mm - 45mm).
- Adaptable bore hole depth from 2 3/8" to 2 3/4" (60mm - 70mm).
- Standard square corner faceplate of 1" x 2 1/4" (25.4mm x 57mm).
- Zinc alloy deadbolt with 1/2" nickel-plated bolt.
- Square corner latch of 1 3/4" x 2 1/4" (44.4mm x 57mm).



Fine Locks®



Fine Locks
DEADBOLTS

Deadbolt

DOUBLE CYLINDER

CV1801US3

UPC: 871193000142

MC-6 / V-6

V1801US5

UPC: 871193000159

MC-10 / V-5

V1801US11

UPC: 871193004492

MC-10 / V-5

CV1801US15A

UPC: 871193003259

MC-6 / V-6

V1801US32

UPC: 871193000128

MC-10 / V-5

V1801US32D

UPC: 871193000135

MC-10 / V-5

V1801US514

UPC: 871193007073

MC-10 / V-5

US32 US3 US5 US32D US15 US15A US11 US514

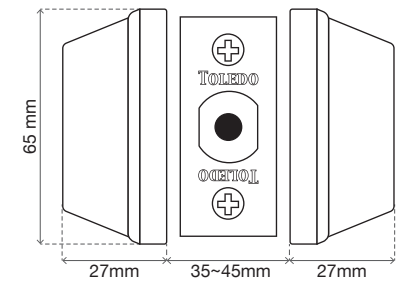

FEATURES:

- Key on both interior and exterior.
- Impact-resistant cylinder for greater security.
- Universal Latch: Adjustable from 2 3/8" to 2 3/4" (60mm - 70mm).
- Door Thickness: Compatible with standard thicknesses from 1 3/8" to 1 3/4" (35mm - 45mm).
- Bore Hole Depth: Adapts to configurations from 2 3/8" to 2 3/4" (60mm - 70mm).
- Faceplate: Standard square corner of 1" x 2 1/4" (25.4mm x 57mm).
- Deadbolt: Made of zinc alloy with a 1/2" nickel-plated bolt for added durability.
- Bolt: Square corner design, measuring 1 3/4" x 2 1/4" (44.4mm x 57mm).
- Standard 5-pin Y1 cylinder for secure operation.

CERTIFICATIONS:

- ANSI/BHMA A156.2 2011/2017 - Grade 3
- Complies with 30-minute fire resistance certification
UL File No. R13776.



DEADBOLT



Fine Locks



Deadbolt

SINGLE CYLINDER

CV1800US3

UPC: 871193000104

MC-6 / V-6

V1800US5

UPC: 871193000111

MC-10 / V-5

V1800US11

UPC: 871193004485

MC-10 / V-5

CV1800US15A

UPC: 871193003242

MC-6 / V-6

V1800US32

UPC: 871193000081

MC-10 / V-5

V1800US32D

UPC: 871193000098

MC-10 / V-5

V1800US514

UPC: 871193007080

MC-10 / V-5

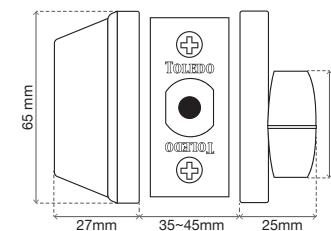

FEATURES:

- Interior thumbturn with exterior key.
- Impact-resistant cylinder for greater security.
- Adjustable latch from 2 3/8" to 2 3/4" (60mm - 70mm).
- Compatible with doors from 1 3/8" to 1 3/4" (35mm - 45mm).
- Adaptable bore hole depth from 2 3/8" to 2 3/4" (60mm - 70mm).
- Standard square corner faceplate of 1" x 2 1/4" (25.4mm x 57mm).
- Zinc alloy deadbolt with 1/2" nickel-plated bolt.
- Bolt: Square corner design, measuring 1 3/4" x 2 1/4" (44.4mm x 57mm).
- Standard 5-pin Y1 cylinder.

CERTIFICATIONS:

- ANSI/BHMA A156.2 2011/2017 - Grade 3
- Complies with 30-minute fire resistance certification UL File No. R13776.



Deadbolt

ONE SIDED

V1805US32D

UPC: 871193001286

MC-10 / V-5

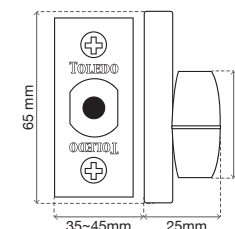

FEATURES:

- Interior thumbturn with exterior blank.
- Adjustable latch from 2 3/8" to 2 3/4" (60mm - 70mm).
- Compatible with doors from 1 3/8" to 1 3/4" (35mm - 45mm).
- Adaptable bore hole depth from 2 3/8" to 2 3/4" (60mm - 70mm).
- Zinc alloy deadbolt with 1/2" nickel-plated bolt.
- Bolt: Square corner design, measuring 1 3/4" x 2 1/4" (44.4mm x 57mm).

DEADBOLT



Fine Locks

Fine Locks
COMBOS





Málaga Knob and Deadbolt Combo

SINGLE CYLINDER

Deadbolt: Interior thumbturn with exterior key.

CV1500MAUS3

UPC: 871193000326

MC-6 / V-6

V1500MAUS5

UPC: 871193000333

MC-10 / V-5

V1500MAUS11

UPC: 871193006076

MC-10 / V-5

V1500MAUS32

UPC: 871193000388

MC-10 / V-5

V1500MAUS32D

UPC: 871193000340

MC-10 / V-5

DOUBLE CYLINDER

Deadbolt: Key on both interior and exterior.

CV1501MAUS3

UPC: 871193000357

MC-6 / V-6

V1501MAUS5

UPC: 871193000364

MC-10 / V-5

V1501MAUS11

UPC: 871193006083

MC-10 / V-5

V1501MAUS32

UPC: 871193000395

MC-10 / V-5

V1501MAUS32D

UPC: 871193000371

MC-10 / V-5



FEATURES:

- Left and Right Function
- Impact-resistant cylinder in keyed entry locks for greater security.
- Universal Latch: Adjustable from 2 3/8" to 2 3/4" (60mm - 70mm) for different door configurations.
- Door Thickness: Compatible with standard thicknesses from 1 3/8" to 1 3/4" (35mm - 45mm).
- Bore Hole Depth: Adapts to configurations from 2 3/8" to 2 3/4" (60mm - 70mm).
- Faceplate: Standard square corner of 1" x 2 1/4" (25.4mm x 57mm).
- Deadbolt: Made of zinc alloy with a 1/2" nickel-plated bolt for added durability.
- Strike Plate: Square corner design, measuring 1 3/4" x 2 1/4" (44.4mm x 57mm).
- Standard 5-pin Y1 cylinder for secure operation.

CERTIFICATIONS:

- ANSI/BHMA A156.2 2011/2017 - Grade 3
- Complies with 30-minute fire resistance certification UL File No. R13776.



COMBOS



Fire Locks®

Ávila Knob and Deadbolt Combo

SINGLE CYLINDER

Deadbolt: Interior thumbturn with exterior key.

V1500AVUS5

UPC: 871193005642

MC-10 / V-5

V1500AVUS32D

UPC: 871193005642

MC-10 / V-5

DOUBLE CYLINDER

Cerrojo: Llave en interior y exterior.

V1501AVUS5

UPC: 871193005635

MC-10 / V-5

V1501AVUS32D

UPC: 871193005635

MC-10 / V-5



FEATURES:

- Left and Right Function
- Impact-resistant cylinder in keyed entry locks for greater security.
- Universal Latch: Adjustable from 2 3/8" to 2 3/4" (60mm - 70mm) for different door configurations.
- Door Thickness: Compatible with standard thicknesses from 1 3/8" to 1 3/4" (35mm - 45mm).
- Bore Hole Depth: Adapts to configurations from 2 3/8" to 2 3/4" (60mm - 70mm).

- Faceplate: Standard square corner of 1" x 2 1/4" (25.4mm x 57mm).
- Deadbolt: Made of zinc alloy with a 1/2" nickel-plated bolt for added durability.
- Strike Plate: Square corner design, measuring 1 3/4" x 2 1/4" (44.4mm x 57mm).
- Standard 5-pin Y1 cylinder for secure operation.

CERTIFICATIONS:

- ANSI/BHMA A156.2 2011/2017 - Grade 3
- Complies with 30-minute fire resistance certification UL File No. R13776.



Segovia Lever and Deadbolt Combo

SINGLE CYLINDER

Deadbolt: Interior thumbturn with exterior key.

V1500SEUS15

UPC: 871193000920

MC-10 / V-5

DOUBLE CYLINDER

Deadbolt: Key on both interior and exterior.

CV1501SEUS3

UPC: 871193000937

MC-10 / V-5

CV1501SEUS5

UPC: 871193000944

MC-6 / V-6

V1501SEUS15

UPC: 871193000951

MC-10 / V-5



FEATURES:

- Left and Right Function
- Impact-resistant cylinder in keyed entry locks for greater security.
- Universal Latch: Adjustable from 2 3/8" to 2 3/4" (60mm - 70mm) for different door configurations.
- Door Thickness: Compatible with standard thicknesses from 1 3/8" to 1 3/4" (35mm - 45mm).
- Bore Hole Depth: Adapts to configurations from 2 3/8" to 2 3/4" (60mm - 70mm).

- Faceplate: Standard square corner of 1" x 2 1/4" (25.4mm x 57mm).
- Deadbolt: Made of zinc alloy with a 1/2" nickel-plated bolt for added durability.
- Strike Plate: Square corner design, measuring 1 3/4" x 2 1/4" (44.4mm x 57mm).
- Standard 5-pin Y1 cylinder for secure operation.

CERTIFICATIONS:

- ANSI/BHMA A156.2 2011/2017 - Grade 3
- Complies with 30-minute fire resistance certification UL File No. R13776.



US32 US3 US5 US32D US15 US15A US11 US514



Barcelona Lever and Deadbolt Combo

SINGLE CYLINDER

Deadbolt: Interior thumbturn with exterior key.

V1500BAUS5

UPC: 871193001996

MC-10 / V-5

V1500BAUS15

UPC: 871193003266

MC-10 / V-5

DOUBLE CYLINDER

Deadbolt: Key on both interior and exterior.

V1501BAUS5

UPC: 871193002009

MC-10 / V-5

V1501BAUS15

UPC: 871193003273

MC-10 / V-5



FEATURES:

- Left and Right Function
- Impact-resistant cylinder in keyed entry locks for greater security.
- Universal Latch: Adjustable from 2 3/8" to 2 3/4" (60mm - 70mm) for different door configurations.
- Door Thickness: Compatible with standard thicknesses from 1 3/8" to 1 3/4" (35mm - 45mm).
- Bore Hole Depth: Adapts to configurations from 2 3/8" to 2 3/4" (60mm - 70mm).

- Faceplate: Standard square corner of 1" x 2 1/4" (25.4mm x 57mm).
- Deadbolt: Made of zinc alloy with a 1/2" nickel-plated bolt for added durability.
- Strike Plate: Square corner design, measuring 1 3/4" x 2 1/4" (44.4mm x 57mm).
- Standard 5-pin Y1 cylinder for secure operation.

CERTIFICATIONS:

- ANSI/BHMA A156.2 2011/2017 - Grade 3
- Complies with 30-minute fire resistance certification UL File No. R13776.



Jaén Lever and Deadbolt Combo

SINGLE CYLINDER

Deadbolt: Interior thumbturn with exterior key.

V1500JAUS5

UPC: 871193004430

MC-10 / V-5

CV1500JAUS11

UPC: 871193004447

MC-6 / V-6

V1500JAUS15

UPC: 871193001811

MC-10 / V-5

DOUBLE CYLINDER

Deadbolt: Key on both interior and exterior.

V1501JAUS5

UPC: 871193002016

MC-10 / V-5

CV1501JAUS11

UPC: 871193004454

MC-6 / V-6

V1501JAUS15

UPC: 871193001804

MC-10 / V-5



FEATURES:

- Left and Right Function
- Impact-resistant cylinder in keyed entry locks for greater security.
- Universal Latch: Adjustable from 2 3/8" to 2 3/4" (60mm - 70mm) for different door configurations.
- Door Thickness: Compatible with standard thicknesses from 1 3/8" to 1 3/4" (35mm - 45mm).
- Bore Hole Depth: Adapts to configurations from 2 3/8" to 2 3/4" (60mm - 70mm).

- Faceplate: Standard square corner of 1" x 2 1/4" (25.4mm x 57mm).
- Deadbolt: Made of zinc alloy with a 1/2" nickel-plated bolt for added durability.
- Strike Plate: Square corner design, measuring 1 3/4" x 2 1/4" (44.4mm x 57mm).
- Standard 5-pin Y1 cylinder for secure operation.

CERTIFICATIONS:

- ANSI/BHMA A156.2 2011/2017 - Grade 3
- Complies with 30-minute fire resistance certification UL File No. R13776.



COMBOS



Fire Locks®

HANDLESETS

A wide range of models and finishes to suit any door style. With a design that combines durability and elegance, they are the perfect choice to enhance the entryway of any space in the home.





Decorative Lock Oviedo - Exterior Function

SINGLE CYLINDER

Deadbolt: Interior thumbturn with exterior key.

V1600VMAUS5

UPC: 871193000241

MC-6 / V-1

V1600VMAUS11

UPC: 871193001972

MC-6 / V-1

V1600VMAUS15

UPC: 871193000227

MC-6 / V-1

V1600VSAUS514 *

UPC: 871193007059

MC-6 / V-1

DOUBLE CYLINDER

Deadbolt: Key on both interior and exterior.

V1601OVMAUS5

UPC: 871193000272

MC-6 / V-1

V1601OVMAUS11

UPC: 871193001989

MC-6 / V-1

V1601OVMAUS15

UPC: 871193000258

MC-6 / V-1

V1601OVSAUS514 *

UPC: 871193007066

MC-6 / V-1



FEATURES:

- Impact-resistant cylinder for greater security.
- Adjustable latch from 2 3/8" to 2 3/4" (60mm - 70mm).
- Compatible with doors from 1 3/8" to 1 3/4" (35mm - 45mm).
- Adaptable bore hole depth from 2 3/8" to 2 3/4" (60mm - 70mm).
- Standard square corner faceplate of 1" x 2 1/4" (25.4mm x 57mm).
- Zinc alloy deadbolt with 1/2" nickel-plated bolt.
- Square corner latch of 1 3/4" x 2 1/4" (44.4mm x 57mm).
- Standard 5-pin Y1 cylinder.

CERTIFICATIONS:

- **DEADBOLT: ANSI/BHMA A156.2 2011/2017 - Grade 3.**
- Complies with 30-minute fire resistance certification
UL File No. R13776.



HANDLESETS



Fine Locks

Decorative Lock Córdoba - Exterior Function

SINGLE CYLINDER

Deadbolt: Interior thumbturn with exterior key.

V1600COCAUS3

UPC: 871193000418

MC-6 / V-1

V1600COCAUS5

UPC: 871193000425

MC-6 / V-1

V1600COCAUS15

UPC: 871193000401

MC-6 / V-1

V1600COCAUS15A

UPC: 871193003280

MC-6 / V-1

DOUBLE CYLINDER

Deadbolt: Key on both interior and exterior.

V161COCAUS3

UPC: 871193000449

MC-6 / V-1

V1601COCAUS5

UPC: 871193000456

MC-6 / V-1

V1601COCAUS15

UPC: 871193000432

MC-6 / V-1



FEATURES:

- Impact-resistant cylinder for greater security.
- Adjustable latch from 2 3/8" to 2 3/4" (60mm - 70mm).
- Compatible with doors from 1 3/8" to 1 3/4" (35mm - 45mm).
- Adaptable bore hole depth from 2 3/8" to 2 3/4" (60mm - 70mm).
- Standard square corner faceplate of 1" x 2 1/4" (25.4mm x 57mm).
- Zinc alloy deadbolt with 1/2" nickel-plated bolt.
- Square corner latch of 1 3/4" x 2 1/4" (44.4mm x 57mm).
- Standard 5-pin Y1 cylinder.



CERTIFICATIONS:

- DEADBOLT: ANSI/BHMA A156.2 2011/2017 - Grade 3.
- Complies with 30-minute fire resistance certification UL File No. R13776.



Decorative Lock Alicante - Exterior Function

SINGLE CYLINDER

Deadbolt: Interior thumbturn with exterior key.

V1600ALBAUS15

UPC: 871193009367

MC-6 / V-1



FEATURES:

- Impact-resistant cylinder for greater security.
- Adjustable latch from 2 3/8" to 2 3/4" (60mm - 70mm).
- Compatible with doors from 1 3/8" to 1 3/4" (35mm - 45mm).
- Adaptable bore hole depth from 2 3/8" to 2 3/4" (60mm - 70mm).
- Standard square corner faceplate of 1" x 2 1/4" (25.4mm x 57mm).
- Zinc alloy deadbolt with 1/2" nickel-plated bolt.
- Square corner latch of 1 3/4" x 2 1/4" (44.4mm x 57mm).
- Standard 5-pin Y1 cylinder.



CERTIFICATIONS:

- DEADBOLT: ANSI/BHMA A156.2 2011/2017 - Grade 3.
- Complies with 30-minute fire resistance certification UL File No. R13776.



US32 US3 US5 US32D US15 US15A US11 US514

**FEATURES:**

- Impact-resistant cylinder for greater security.
- Adjustable latch from 2 3/8" to 2 3/4" (60mm - 70mm).
- Compatible with doors from 1 3/8" to 1 3/4" (35mm - 45mm).
- Adaptable bore hole depth from 2 3/8" to 2 3/4" (60mm - 70mm).
- Standard square corner faceplate of 1" x 2 1/4" (25.4mm x 57mm).
- Zinc alloy deadbolt with 1/2" nickel-plated bolt.
- Square corner latch of 1 3/4" x 2 1/4" (44.4mm x 57mm).
- Standard 5-pin Y1 cylinder.

**CERTIFICATIONS:**

- **DEADBOLT: ANSI/BHMA A156.2 2011/2017 - Grade 3.**
- Complies with 30-minute fire resistance certification UL File No. R13776.

**FEATURES:**

- Decorative-style handle with low-profile square rosette.
- Impact-resistant cylinder for greater security.
- Adjustable latch from 2 3/8" to 2 3/4" (60mm - 70mm).
- Compatible with doors from 1 3/8" to 1 3/4" (35mm - 45mm).
- Adaptable bore hole depth from 2 3/8" to 2 3/4" (60mm - 70mm).
- Standard square corner faceplate of 1" x 2 1/4" (25.4mm x 57mm).
- Zinc alloy deadbolt with 1/2" nickel-plated bolt.
- Square corner latch of 1 3/4" x 2 1/4" (44.4mm x 57mm).
- Standard 5-pin Y1 cylinder.

**CERTIFICATIONS:**

- **DEADBOLT: ANSI/BHMA A156.2 2011/2017 - Grade 3.**
- Complies with 30-minute fire resistance certification UL File No. R13776.

**Decorative Lock Granada - Exterior Function****SINGLE CYLINDER**

Deadbolt: Interior thumbturn with exterior key.

V1600GRAVUS5

UPC: 871193000296

MC-6 / V-1

DOUBLE CYLINDER

Deadbolt: Key on both interior and exterior.

V1601GRAVUS5

UPC: 871193000319

MC-6 / V-1

**Decorative Lock Lugo - Exterior Function****SINGLE CYLINDER**

Deadbolt: Interior thumbturn with exterior key.

V1600LPLUUS15

UPC: 871193006960

MC-6 / V-1

V1600LPLUUS514

UPC: 871193009138

MC-6 / V-1

DOUBLE CYLINDER

Deadbolt: Key on both interior and exterior.

V1601LPLUUS15

UPC: 871193006977

MC-6 / V-1

V1601LPLUUS514

UPC: 871193009145

MC-6 / V-1



EUROPEAN

HANDLESETS





EUROPEAN KNOBSETS

The Toledo European Series combines modern design with high security standards, offering robust and elegant locks for the home. With a variety of finishes and standout quality, this line is ideal for those seeking protection without compromising on aesthetics in every corner of their space.



Vigo Knob - Square Rosette Exterior / Interior Lock

KEYED ENTRY

CV1900VIUS4

UPC: 810055041176

MC-6 / V-3

CV1900VIUS32D

UPC: 871193009169

MC-6 / V-3

CV1900VIUS514

UPC: 871193009336

MC-6 / V-3

PRIVACY

CV1920VIUS4

UPC: 810055041183

MC-6 / V-3

CV1920VIUS32D

UPC: 871193002313

MC-6 / V-3

CV1920VIUS514

UPC: 871193009343

MC-6 / V-3

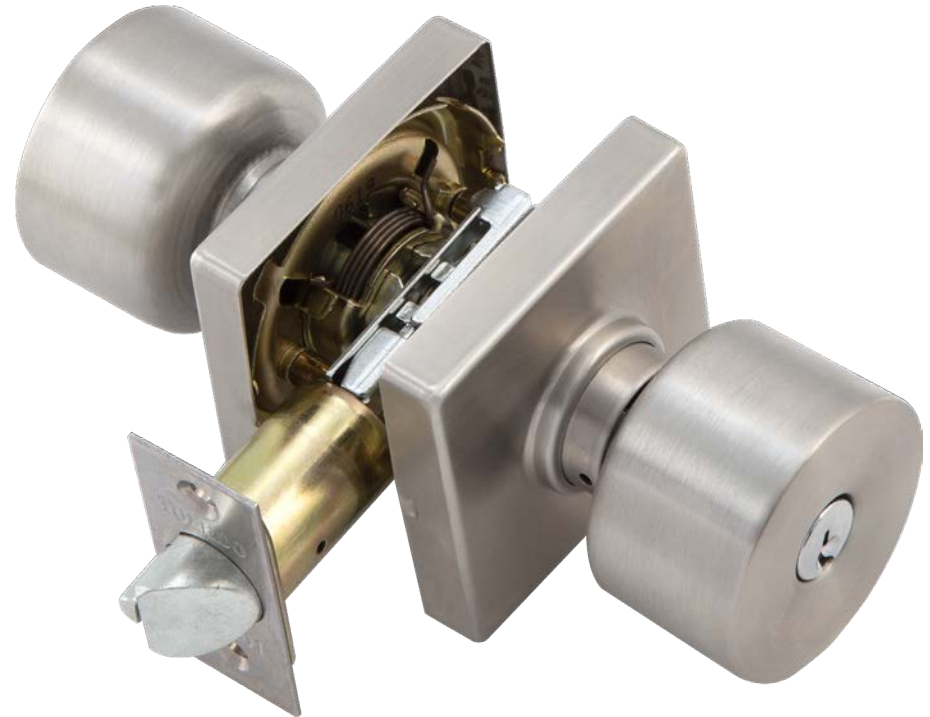
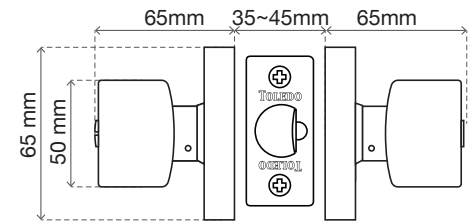

Known for their modern and functional design, Toledo European locks offer style and reliable security. Crafted from high-quality materials, they are ideal for both homes and businesses.

FEATURES:

- Decorative-style knob with a low-profile square rosette.
- Impact-resistant cylinder in keyed entry locks for enhanced security.
- Universal Latch: Adjustable from 2 3/8" to 2 3/4" (60mm - 70mm).
- Door Thickness: Compatible with standard thicknesses of 1 3/8" to 1 3/4" (35mm - 45mm).
- Bore Hole Depth: Fits configurations from 2 3/8" to 2 3/4" (60mm - 70mm).
- Faceplate: Standard square corner, 1" x 2 1/4" (25.4mm x 57mm).
- Deadbolt: Made from zinc alloy with a 1/2" nickel-plated bolt for added durability.
- Strike Plate: Square corner design, measuring 1 3/4" x 2 1/4" (44.4mm x 57mm).
- Standard 5-pin Y1 cylinder for secure operation.

CERTIFICATIONS:

- ANSI/BHMA A156.2 2011/2017 - Grade 3
- Complies with 30-minute fire resistance certification
UL File No. R13776.



KNOBSET



EUROPEAN®

EUROPEAN LEVERS



US32 US4 US5 US32D US15 US15A US11 US514



Lugo Lever - Square Rosette Exterior / Interior Lock

KEYED ENTRY

CV1900LUUS4
 UPC: 810055041190
 MC-6 / V-3

CV1900LUUS15
 UPC: 871193006793
 MC-6 / V-3

CV1900LUUS514
 UPC: 871193009107
 MC-6 / V-3

PRIVACY

CV1920LUUS4
 UPC: 810055041206
 MC-6 / V-3

CV1920LUUS15
 UPC: 871193006809
 MC-6 / V-3

CV1920LUUS514
 UPC: 871193009091
 MC-6 / V-3

HALL / CLOSET

CV1910LUUS15
 UPC: 871193001514
 MC-6 / V-3

FEATURES:

- Decorative-style handle with a low-profile square rosette.
- Impact-resistant cylinder in keyed entry locks.
- Left and Right Function.
- Universal Latch: Adjustable from 2 3/8" to 2 3/4" (60mm - 70mm).
- Compatible with standard door thicknesses of 1 3/8" to 1 3/4" (35mm - 45mm).
- Bore Hole Depth: Fits 2 3/8" to 2 3/4" (60mm - 70mm).

- Faceplate: Standard square corner, 1" x 2 1/4" (25.4mm x 57mm).
- Strike Plate: Square corner design, measuring 1 3/4" x 2 1/4" (44.4mm x 57mm).
- Standard 5-pin Y1 cylinder for secure operation.

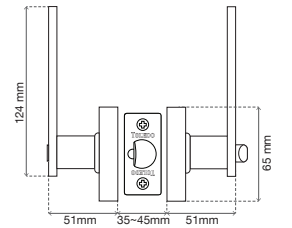

CERTIFICATIONS:

- ANSI/BHMA A156.2 2011/2017 - Grade 3
- Complies with 30-minute fire resistance certification UL File No. R13776.



Girona Lever - Square Rosette Exterior / Interior Lock

KEYED ENTRY

CV1900GIUS15
 UPC: 871193006984
 MC-6 / V-3

PRIVACY

CV1920GIUS15
 UPC: 871193006991
 MC-6 / V-3

FEATURES:

- Decorative-style handle with a low-profile square rosette.
- Impact-resistant cylinder in keyed entry locks.
- Left and Right Function.
- Universal Latch: Adjustable from 2 3/8" to 2 3/4" (60mm - 70mm).
- Door Thickness: Compatible with standard thicknesses of 1 3/8" to 1 3/4" (35mm - 45mm).

- Bore Hole Depth: Fits 2 3/8" to 2 3/4" (60mm - 70mm).
- Faceplate: Standard square corner, 1" x 2 1/4" (25.4mm x 57mm).
- Strike Plate: Square corner design, measuring 1 3/4" x 2 1/4" (44.4mm x 57mm).
- Standard 5-pin Y1 cylinder for secure operation.

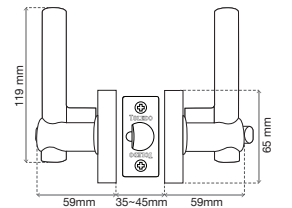

CERTIFICATIONS:

- ANSI/BHMA A156.2 2011/2017 - Grade 3
- Complies with 30-minute fire resistance certification UL File No. R13776.



Mérida Lever - Round Rosette Exterior/Interior Lock

KEYED ENTRY CV1900MEUS15

UPC: 871193009428

MC-6 / V-3

PRIVACY CV1920MEUS15

UPC: 871193009411

MC-6 / V-3

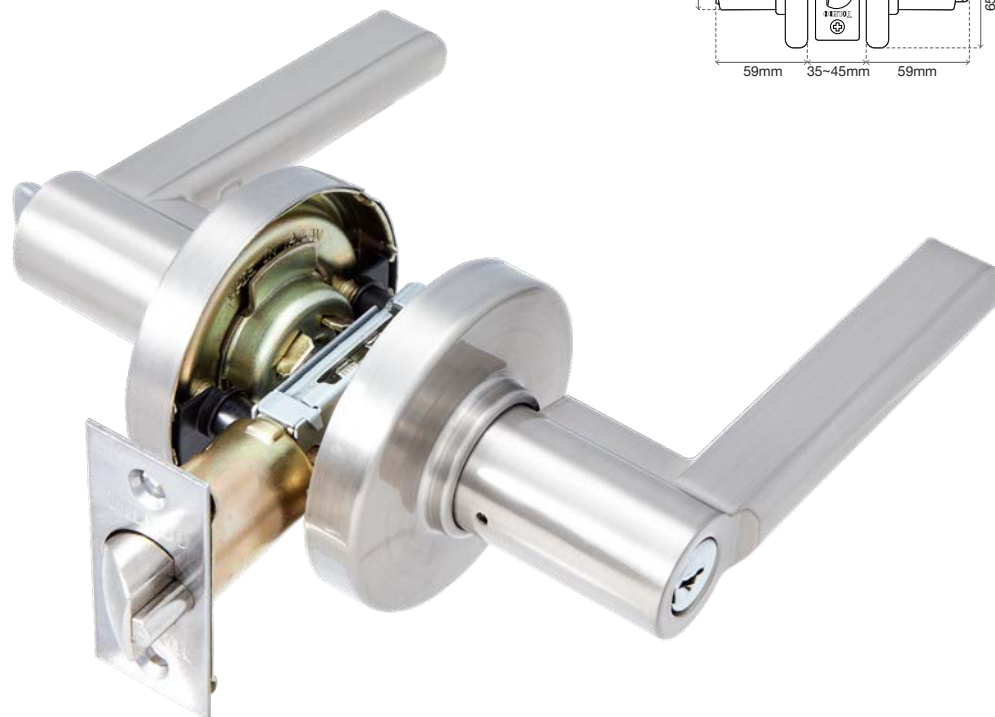
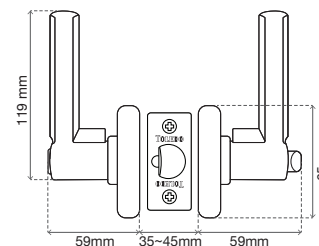

Known for their modern and functional design, Toledo European locks provide style and reliable security. Crafted from high-quality materials, they are ideal for both homes and businesses.

FEATURES:

- Decorative-style handle with a low-profile round rosette.
- Impact-resistant cylinder in keyed entry locks for enhanced security.
- Universal Latch: Adjustable from 2 3/8" to 2 3/4" (60mm - 70mm).
- Left and Right Function.
- Door Thickness: Compatible with standard thicknesses of 1 3/8" to 1 3/4" (35mm - 45mm).
- Bore Hole Depth: Fits configurations from 2 3/8" to 2 3/4" (60mm - 70mm).
- Faceplate: Standard square corner, 1" x 2 1/4" (25.4mm x 57mm).
- Strike Plate: Square corner design, measuring 1 3/4" x 2 1/4" (44.4mm x 57mm).
- Standard 5-pin Y1 cylinder for secure operation.

CERTIFICATIONS:

- **ANSI/BHMA A156.2 2011/2017 - Grade 3**
- Complies with 30-minute fire resistance certification
UL File No. R13776.



LEVERSET



EUROPEAN®

EUROPEAN DEADBOLTS



Low-Profile Deadbolt - Square Rosette

SINGLE CYLINDER

CV1800SQRUS4

UPC: 810055041213

MC-6 / V-3

CV1800SQRUS15

UPC: 871193006779

MC-6 / V-3

CV1800SQRUS514

UPC: 871193009114

MC-6 / V-3

DOUBLE CYLINDER

CV1801SQRUS4

UPC: 810055041220

MC-6 / V-3

CV1801SQRUS15

UPC: 871193006786

MC-6 / V-3

CV1801SQRUS514

UPC: 871193009121

MC-6 / V-3

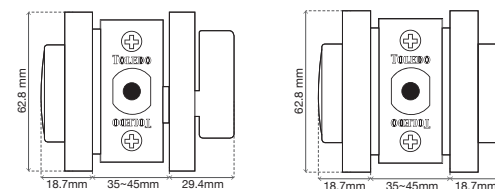

FEATURES:

- Decorative-style deadbolt with a low-profile square rosette.
- Impact-resistant cylinder for enhanced security.
- Adjustable latch from 2 3/8" to 2 3/4" (60mm - 70mm).
- Compatible with doors from 1 3/8" to 1 3/4" (35mm - 45mm).
- Adaptable bore hole depth from 2 3/8" to 2 3/4" (60mm - 70mm).
- Standard square corner faceplate of 1" x 2 1/4" (25.4mm x 57mm).
- Zinc alloy deadbolt with a 1/2" nickel-plated bolt.
- Square corner strike plate measuring 1 3/4" x 2 1/4" (44.4mm x 57mm).
- Standard 5-pin Y1 cylinder.



CERTIFICATIONS:

- ANSI/BHMA A156.2 2011/2017 - Grade 3
- Complies with 30-minute fire resistance certification UL File No. R13776.



Low-Profile Deadbolt - Round Rosette

SINGLE CYLINDER

CV1800LPUS4

UPC: 810055041268

MC-6 / V-3

CV1800LPUS15

UPC: 871193005628

MC-6 / V-3

DOUBLE CYLINDER

CV1801LPUS4

UPC: 810055041251

MC-6 / V-3

CV1800LPUS15

UPC: 871193005611

MC-6 / V-3

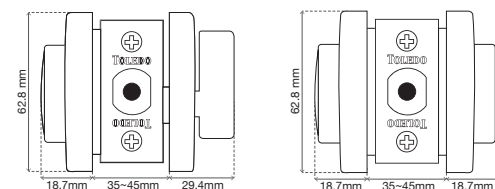

FEATURES:

- Decorative-style deadbolt with a low-profile round rosette.
- Impact-resistant cylinder for enhanced security.
- Adjustable latch from 2 3/8" to 2 3/4" (60mm - 70mm).
- Compatible with doors from 1 3/8" to 1 3/4" (35mm - 45mm).
- Adaptable bore hole depth from 2 3/8" to 2 3/4" (60mm - 70mm).
- Standard square corner faceplate of 1" x 2 1/4" (25.4mm x 57mm).
- Zinc alloy deadbolt with a 1/2" nickel-plated bolt.
- Square corner strike plate measuring 1 3/4" x 2 1/4" (44.4mm x 57mm).
- Standard 5-pin Y1 cylinder.



CERTIFICATIONS:

- ANSI/BHMA A156.2 2011/2017 - Grade 3
- Complies with 30-minute fire resistance certification UL File No. R13776.



US32 US4 US5 US32D US15 US15A US11 US514



Low-Profile Deadbolt - Square Rosette

SINGLE CYLINDER

CV1800XLSQUS15

UPC: 810055041626

MC-6 / V-3

CV1800XLSQUS514

UPC: 810055041633

MC-6 / V-3

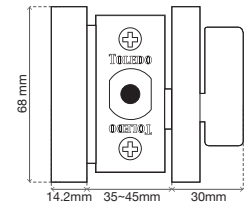

FEATURES:

- Decorative-style deadbolt with a low-profile square rosette.
- Interior thumbturn with exterior key.
- Impact-resistant cylinder for enhanced security.
- Adjustable latch from 2 3/8" to 2 3/4" (60mm - 70mm).
- Compatible with doors from 1 3/8" to 1 3/4" (35mm - 45mm).
- Adaptable bore hole depth from 2 3/8" to 2 3/4" (60mm - 70mm).
- Standard square corner faceplate of 1" x 2 1/4" (25.4mm x 57mm).
- Zinc alloy deadbolt with a 1/2" nickel-plated bolt.
- Square corner strike plate measuring 1 3/4" x 2 1/4" (44.4mm x 57mm).
- Standard 5-pin Y1 cylinder.



Low-Profile Deadbolt - Round Rosette



SINGLE CYLINDER

CV1800XLPUS514

UPC: 810055041619

MC-6 / V-3

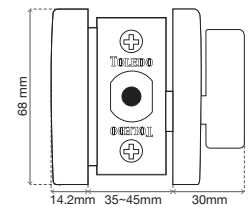

FEATURES:

- Decorative-style deadbolt with a low-profile round rosette.
- Interior thumbturn with exterior key.
- Impact-resistant cylinder for enhanced security.
- Adjustable latch from 2 3/8" to 2 3/4" (60mm - 70mm).
- Compatible with doors from 1 3/8" to 1 3/4" (35mm - 45mm).
- Adaptable bore hole depth from 2 3/8" to 2 3/4" (60mm - 70mm).
- Standard square corner faceplate of 1" x 2 1/4" (25.4mm x 57mm).
- Zinc alloy deadbolt with a 1/2" nickel-plated bolt.
- Square corner strike plate measuring 1 3/4" x 2 1/4" (44.4mm x 57mm).
- Standard 5-pin Y1 cylinder.



DEADBOLTS



EUROPEAN®

EUROPEAN COMBOS



US32 US3 US5 US32D US15 US15A US11 US514



Lugo Lever and Deadbolt Combo

SINGLE CYLINDER

Deadbolt: Interior thumbturn with exterior key.

CV1500LUUS15

UPC: 871193009299

MC-6 / V-3

CV1500LUUS514

UPC: 871193009312

MC-6 / V-3

DOUBLE CYLINDER

Deadbolt: Key on both interior and exterior.

CV1501LUUS15

UPC: 871193009305

MC-6 / V-3

CV1501LUUS514

UPC: 871193009329

MC-6 / V-3



FEATURES:

- Decorative-style handle with a low-profile square rosette.
- Left and Right Function.
- Impact-resistant cylinder for enhanced security.
- Adjustable latch from 2 3/8" to 2 3/4" (60mm - 70mm).
- Compatible with doors from 1 3/8" to 1 3/4" (35mm - 45mm).
- Adaptable bore hole depth from 2 3/8" to 2 3/4" (60mm - 70mm).
- Standard square corner faceplate of 1" x 2 1/4" (25.4mm x 57mm).
- Zinc alloy deadbolt with a 1/2" nickel-plated bolt.
- Square corner strike plate measuring 1 3/4" x 2 1/4" (44.4mm x 57mm).
- Standard 5-pin Y1 cylinder.

CERTIFICATIONS:

- ANSI/BHMA A156.2 2011/2017 - Grade 3
- Complies with 30-minute fire resistance certification UL File No. R13776.



Mérida Lever and Deadbolt Combo

SINGLE CYLINDER

Deadbolt: Interior thumbturn with exterior key.

CV1500MEUS15

UPC: 871193009435

MC-6 / V-3

DOUBLE CYLINDER

Deadbolt: Key on both interior and exterior.

CV1501MEUS15

UPC: 871193009442

MC-6 / V-3



FEATURES:

- Decorative-style handle with a low-profile round rosette.
- Left and Right Function.
- Impact-resistant cylinder for enhanced security.
- Adjustable latch from 2 3/8" to 2 3/4" (60mm - 70mm).
- Compatible with doors from 1 3/8" to 1 3/4" (35mm - 45mm).
- Adaptable bore hole depth from 2 3/8" to 2 3/4" (60mm - 70mm).
- Standard square corner faceplate of 1" x 2 1/4" (25.4mm x 57mm).
- Zinc alloy deadbolt with a 1/2" nickel-plated bolt.
- Square corner latch measuring 1 3/4" x 2 1/4" (44.4mm x 57mm).
- Standard 5-pin Y1 cylinder.

CERTIFICATIONS:

- ANSI/BHMA A156.2 2011/2017 - Grade 3
- Complies with 30-minute fire resistance certification UL File No. R13776.



COMBOS



EUROPEAN®

ELECTRONIC

The Toledo Electronic Series combines advanced technology and functional design to deliver modern and reliable security solutions. Now, with the addition of the new Toledo Nexus smart locks, the series reaches a new level.

The Nexus locks offer multiple secure access methods, such as codes, cards, fingerprint recognition, and remote control. They easily integrate with an app via Bluetooth and Wi-Fi, enabling remote management of home security. The perfect choice for those seeking convenience, technological innovation, and dependable protection.



US32 US3 US5 US32D US15 US15A US11 US514



Smart Mortise Locks

KEYED ENTRY

V190MNSUS15

UPC: 810055044528

MC-4 / V-1

V190MNSUS514

UPC: 810055042609

MC-4 / V-1



Multiple Access Options:

- Bluetooth (TT Lock APP)
- Fingerprint (up to 200)
- Code (up to 150)
- Key (2 included)
- Card (3 included)
- WiFi (1 connection bridge included)*
- Compatible with Alexa and Google Assistant.



FEATURES:

- Automatic locking.
- Reversible function for right and left-handed doors.
- Waterproof rubber plate, suitable for outdoor use.
- Aluminum body with stainless steel 304 alloy mortise.
- Voice notification: Indicates Lock/Unlock status in Spanish and English.
- Working temperature: -10°C to 55°C.
- Operates with 4 AA alkaline batteries (batteries not included).
- USB emergency power supply.

Door:

- Suitable for all mortises: 45mm - 85mm.
- 4 M5 10mm screws for aluminum doors and 5 M4 20mm screws for wooden doors included.



Smart Mortise Locks

KEYED ENTRY

V190TMNXUS15

UPC: 810055044580

MC-4 / V-1

V190TMNXUS514

UPC: 810055044573

MC-4 / V-1



Multiple Access Options:

- Bluetooth (TT Lock APP)
- Fingerprint (up to 200)
- Code (up to 150)
- Key (2 included)
- Card (3 included)
- WiFi (1 connection bridge included)*
- Compatible with Alexa and Google Assistant.



FEATURES:

- Automatic locking.
- Reversible function for right and left-handed doors.
- Waterproof rubber plate, suitable for outdoor use.
- Aluminum body with stainless steel 304 alloy mortise.
- Voice notification: Indicates Lock/Unlock status in Spanish and English.
- Working temperature: -10°C to 55°C.
- Operates with 4 AA alkaline batteries (batteries not included).
- USB emergency power supply.

Door:

- Suitable for all mortises: 35 mm - 85 mm.
- 4 M5 10mm screws for aluminum doors and 5 M4 20mm screws for wooden doors included.

SMART LOCKS



NEXUS

Smart Lever

KEYED ENTRY

V190NXUS15

UPC: 810055044559

MC-6 / V-1

V190NXUS514

UPC: 810055042593

MC-6 / V-1



Multiple Access Options:

- Bluetooth (TT Lock APP)
- Fingerprint (up to 200)
- Code (up to 150)
- Key (2 included)
- Card (3 included)
- WiFi (1 connection bridge included)*
- Compatible with Alexa and Google Assistant.



FEATURES:

- Automatic locking.
- Reversible function for right and left-handed doors.
- Waterproof rubber plate, suitable for outdoor use.
- Aluminum body with 304 stainless steel alloy latch.
- Voice notification: Indicates Lock/Unlock status in Spanish and English.
- Working temperature: -10°C to 55°C.
- Operates with 4 AA alkaline batteries (batteries not included).
- USB emergency power supply.

Door:

• Suitable for standard distances between the knob and door edge from 2 3/8" (60mm) to 2 3/4" (70mm). Compatible with metal or wooden doors from 1 3/8" to 2" (35mm - 51mm) thick. Front hole diameter of 2 1/8" (54mm) and side hole diameter of 1" (25.4mm).

Smart Lever

KEYED ENTRY

V190SNXUS15

UPC: 810055044566

MC-6 / V-1

V190SNXUS514

UPC: 810055042630

MC-10 / V-1



Multiple Access Options:

- Bluetooth (TT Lock APP)
- Fingerprint (up to 200)
- Code (up to 150)
- Key (2 included)
- Card (3 included)
- WiFi (1 connection bridge included)*
- Compatible with Alexa and Google Assistant.



FEATURES:

- Automatic locking.
- Reversible function for right and left-handed doors.
- Waterproof rubber plate, suitable for outdoor use.
- Aluminum body with 304 stainless steel alloy latch.
- Voice notification: Indicates Lock/Unlock status in Spanish and English.
- Working temperature: -10°C to 55°C.
- Operates with 4 AAA alkaline batteries (batteries not included).
- USB emergency power supply.

Door:

• Suitable for standard distances between the knob and door edge from 2 3/8" (60mm) to 2 3/4" (70mm). Compatible with metal or wooden doors from 1 3/8" to 2" (35mm - 51mm) thick. Front hole diameter of 2 1/8" (54mm) and side hole diameter of 1" (25.4mm).



US32 US3 US5 US32D US15 US15A US11 US514

**Multiple Access Options:**

- Bluetooth (TT Lock APP)
- Fingerprint (up to 200)
- Code (up to 150)
- Key (2 included)
- Card (3 included)
- WiFi (1 connection bridge included)*
- Compatible with Alexa and Google Assistant.

**FEATURES:**

- Bloqueo automático a través del App.
- Pestillo Magnético: Sistema de cierre automático que se activa al acercarse a la cerradura, garantizando un cierre preciso y seguro al cerrar la puerta.
- Placa de goma impermeable, apta para uso exterior.
- Cuerpo en aluminio y mortaja en STAINLESS STEEL aleación 304.
- Notificación por voz: Indica Bloqueo/Desbloqueo en Español e Inglés.
- Temperatura de trabajo: -10°C a 55°C
- Opera con 4 baterías alcalinas AA. (Baterías no se incluyen).
- Alimentación de emergencia USB.

Door:

- Suitable for standard distances between the knob and door edge from 2 3/8" (60mm) to 2 3/4" (70mm). Compatible with metal or wooden doors from 1 3/8" to 2" (35mm – 51mm) thick. Front hole diameter of 2 1/8" (54mm) and side hole diameter of 1" (25.4mm).

**Multiple Access Options:**

- Bluetooth (TT Lock APP)
- Fingerprint (up to 200)
- Code (up to 150)
- Key (2 included)
- Card (3 included)
- WiFi (1 connection bridge included)*
- Compatible with Alexa and Google Assistant.

**FEATURES:**

- Bloqueo automático a través del App.
- Pestillo Magnético: Sistema de cierre automático que se activa al acercarse a la cerradura, garantizando un cierre preciso y seguro al cerrar la puerta.
- Placa de goma impermeable, apta para uso exterior.
- Cuerpo en aluminio y mortaja en STAINLESS STEEL aleación 304.
- Notificación por voz: Indica Bloqueo/Desbloqueo en Español e Inglés.
- Temperatura de trabajo: -10°C a 55°C
- Opera con 4 baterías alcalinas AA. (Baterías no se incluyen).
- Alimentación de emergencia USB.

Door:

- Suitable for standard distances between the knob and door edge from 2 3/8" (60mm) to 2 3/4" (70mm). Compatible with metal or wooden doors from 1 3/8" to 2" (35mm – 51mm) thick. Front hole diameter of 2 1/8" (54mm) and side hole diameter of 1" (25.4mm).

Smart Deadbolt- Square Design**SINGLE CYLINDER****V180NXUS15**

UPC: 810055044542

MC-10 / V-1

V180NXUS514

UPC: 810055042616

MC-10 / V-1

**Smart Deadbolt- Round Design****SINGLE CYLINDER****V180NXRUS15**

UPC: 810055044535

MC-10 / V-1

V180NXRUS514

UPC: 810055042623

MC-10 / V-1

**SMART LOCKS****NEXUS**

Biometric Electronic Deadbolt

SINGLE CYLINDER

CV180BMUS15

UPC: 871193009886

MC-6 / V-1

CV180BMUS514

UPC: 871193009893

MC-6 / V-1



Multiple Access Options:

- Fingerprint (Up to 50)
- Code (Up to 10)



FEATURES:

- Access Method: Keypad and fingerprint reader.
- Security Features: Automatic locking, locked bolt or door not closed alarm.
- Fingerprint Capacity: Up to 50 encrypted fingerprints stored locally (not in the cloud).
- Fingerprint Recognition: Advanced FPC module from Sweden for fast and secure unlocking.
- Access Codes: 1 master code and 10 user codes, ranging from 4 to 10 digits.
- Lockout for Failed Attempts: Activates after 5 incorrect code or fingerprint attempts.
- Temporary Code: Generates a one-time use code for single entry.
- Power Supply: Emergency power source via 9V battery.
- Door Compatibility: Suitable for wooden or metal doors 1 3/8" to 1 3/4" (35mm - 51mm) thick. Supports distances from knob to door edge of 2 3/8" (60mm) to 2 3/4" (70mm). Requires a front hole of 2 1/8" (54mm) and a side hole of 1" (25.4mm).

Electronic Deadbolt

SINGLE CYLINDER

CV180EKUS15

UPC: 871193009909

MC-6 / V-1

CV180EKUS514

UPC: 871193009916

MC-6 / V-1



Multiple Access Options:

- Code (Up to 6)
- Key (3 included)



FEATURES:

- Access Method: Numeric keypad and standard key.
- Durability: Water-resistant locking system, suitable for outdoor use.
- Keypad: LED illumination for easy use in the dark.
- Access Codes: 1 master code and up to 6 secondary codes, ranging from 4 to 10 digits.
- Security Features: Automatic locking and lockout after 5 incorrect attempts.
- Door Compatibility: Suitable for wooden or metal doors 1 3/8" to 1 3/4" (35mm - 51mm) thick. Supports distances from knob to door edge of 2 3/8" (60mm) to 2 3/4" (70mm). Requires a front hole of 2 1/8" (54mm) and a side hole of 1" (25.4mm).



Electronic Deadbolt

SINGLE CYLINDER

CV180EUS15

UPC: 871193000975

MC-6 / V-1



Multiple Access Options:

- Code (Up to 6)
- Key (3 included)
- Remote Control **



FEATURES:

- Durability and Security: Anti-tamper technology and stainless steel finish, providing durability and elegance.
- Access Methods: Infrared remote control, numeric code, and standard key.
- Access Codes: 1 master code and 6 user codes ranging from 4 to 10 digits.
- Failed Attempt Lockout: Automatic lockout activates after five incorrect code attempts. Reactivates after 45 seconds.
- Automatic Locking: Automatic locking function available when activated.
- Keypad: LED illumination for use in low-light conditions.
- Power Supply: Operates with 4 AA alkaline batteries for easy replacement.
- Door Compatibility: Suitable for wooden or metal doors 1 3/8" to 1 3/4" (35mm - 51mm) thick. Supports distances from knob to door edge of 2 3/8" (60mm) to 2 3/4" (70mm). Requires a front hole of 2 1/8" (54mm) and a side hole of 1" (25.4mm).

** Also sold separately, item#: **KEYPADLOCKREMOT**

Electronic Deadbolt

SINGLE CYLINDER

V180KUS15

UPC: 871193007653

MC-6 / V-1



Multiple Access Options:

- Code (Up to 10)
- Key (3 included)



FEATURES:

- Convenient Dual Access: Offers entry via access code or standard key.
- Water-Resistant System: Ideal for outdoor use and variable weather conditions.
- Integrated LED Keypad: Facilitates use in low-light conditions or darkness.
- Access Codes: 1 master code and 6 user codes ranging from 4 to 10 digits.
- Automatic Locking: Automatic locking function available when activated.
- Failed Attempt Lockout: Automatic lockout activates after five incorrect code attempts.
- Door Compatibility: Suitable for wooden or metal doors 1 3/8" to 1 3/4" (35mm - 51mm) thick. Supports distances from knob to door edge of 2 3/8" (60mm) to 2 3/4" (70mm). Requires a front hole of 2 1/8" (54mm) and a side hole of 1" (25.4mm).

BHMA
CERTIFIED®

DEADBOLTS



ELECTRONIC

Electronic Deadbolt - Touchscreen

SINGLE CYLINDER

CV180TDUS15

UPC: 871193009923

MC-4 / V-1

CV180TDUS514

UPC: 810055040896

MC-4 / V-1



US32 US3 US5 US32D US15 US15A US11 US514



Multiple Access Options:

- Code (Up to 10)
- Key (3 included)



FEATURES:

- Certification: Complies with ANSI Grade 3 and ANSI A156.25 for resistance to dust, rain, and corrosion.
- Security Features: Automatic locking and vacation mode that temporarily disables all codes.
- Touch Operability: Works with gloves and wet hands.
- Indicators: Low battery indicator.
- Access Codes: 1 programming code with 6 digits and up to 10 user codes ranging from 4 to 6 digits.
- Temporary Lockout: Keypad disables after 4 consecutive failed attempts.
- Door Compatibility: Suitable for wooden or metal doors 1 3/8" to 1 3/4" (35mm - 51mm) thick. Supports distances from knob to door edge of 2 3/8" (60mm) to 2 3/4" (70mm). Requires a front hole of 2 1/8" (54mm) and a side hole of 1" (25.4mm).

Electronic Deadbolt

SINGLE CYLINDER

V180BLEUS15

UPC: 871193007639

MC-6 / V-1



Multiple Access Options:

- Code (Up to 10)
- Key (3 included)



FEATURES:

- Connectivity: Built-in Bluetooth.
- Indicators: Visual and audio alerts for enhanced security.
- Durability: Water-resistant system with anti-tampering technology.
- Access Methods: Numeric code, smartphone application, and standard key.
- Access Codes: 1 master code and up to 30 subcodes, modifiable at any time.
- Keypad: LED illumination for use in the dark.
- Door Compatibility: Suitable for wooden or metal doors 1 3/8" to 1 3/4" (35mm - 51mm) thick. Supports distances from knob to door edge of 2 3/8" (60mm) to 2 3/4" (70mm). Requires a front hole of 2 1/8" (54mm) and a side hole of 1" (25.4mm).



US32 US3 US5 US32D US15 US15A US11 US514

**Multiple Access Options:**

- Code (Up to 6)
- Key (3 included)

**FEATURES:**

- Connectivity: Built-in Bluetooth.
- Indicators: Visual and audio notifications for operational status.
- Durability: Waterproof system with anti-tampering technology.
- Access Methods: Access code, smartphone application, and standard key.
- Access Codes: 1 master code and up to 6 subcodes, editable at any time.
- Keypad: Touchscreen with LED illumination for use in the dark.
- Door Compatibility: Suitable for wooden or metal doors 1 3/8" to 1 3/4" (35mm - 51mm) thick. Supports distances from knob to door edge of 2 3/8" (60mm) to 2 3/4" (70mm). Requires a front hole of 2 1/8" (54mm) and a side hole of 1" (25.4mm).

Electronic Deadbolt - Touchscreen**SINGLE CYLINDER****V180TBLEUS15**

UPC: 871193007646

MC-6 / V-1

**Electronic Lock - Jaén Model****KEYED ENTRY****V190EJAUS15**

UPC: 871193004997

MC-6 / V-1

**Multiple Access Options:**

- Code (Up to 6)
- Key (3 included)
- Remote Control **

**FEATURES:**

- Durability and Security: Anti-tampering technology and stainless steel finish, providing durability and elegance.
- Access Methods: Infrared remote control, numeric code, and standard key.
- Access Codes: 1 master code and 6 user codes, ranging from 4 to 10 digits.
- Failed Attempt Lockout: Activates automatic lockout after five incorrect code attempts. Reactivates after 45 seconds.
- Automatic Locking: Automatic locking function available when activated.
- Keypad: LED illumination for use in low-light conditions.
- Power Supply: Operates with 4 AA alkaline batteries for easy replacement.
- Compatibility: Left or right-handed installation.
- Door Compatibility: Suitable for wooden or metal doors 1 3/8" to 1 3/4" (35mm - 51mm) thick. Supports distances from knob to door edge of 2 3/8" (60mm) to 2 3/4" (70mm). Requires a front hole of 2 1/8" (54mm) and a side hole of 1" (25.4mm).

** Also sold separately, item#: **KEYPADLOCKREMOT****CERROJO Y MANGO****ELECTRONIC**

Electronic Touchscreen Handle - Bilbao Model

KEYED ENTRY

V190TBIUS15

UPC: 871193005963

MC-6 / V-1



Multiple Access Options:

- Code (Up to 6)
- Key (3 included)



FEATURES:

- Access Method: Touchscreen and standard key.
- Memory Capacity: 1 master code and up to 6 additional codes, organized into 6 user groups and modifiable at any time.
- Failed Attempt Lockout: Activates automatic lockout after five incorrect code attempts. Reactivates after 45 seconds.
- Keypad: Touchscreen with LED illumination for use in the dark.
- Compatibility: Left or right-handed installation.
- Door Compatibility: Suitable for wooden or metal doors 1 3/8" to 1 3/4" (35mm - 51mm) thick. Supports distances from knob to door edge of 2 3/8" (60mm) to 2 3/4" (70mm). Requires a front hole of 2 1/8" (54mm) and a side hole of 1" (25.4mm).

Electronic Handle - Girona Model

KEYED ENTRY

V190EGIUS15

UPC: 810055042357

MC-4 / V-1



Multiple Access Options:

- Code (Up to 6)
- Key (3 included)



FEATURES:

- Access Method: Numeric keypad and standard key.
- Security Feature: Automatic locking activated via button.
- Vacation Mode: Temporarily disables all user codes.
- Indicator: Low battery notification.
- Access Codes: 1 programming code (6 digits) and up to 20 user codes ranging from 4 to 8 digits.
- Temporary Lockout: Activates after 4 consecutive failed attempts.
- Extreme Temperature Resistance: Operates between -31 °F to 150.8 °F (-35 °C to 66 °C).
- Compatibility: Left or right-handed installation.
- Door Compatibility: Suitable for wooden or metal doors 1 3/8" to 1 3/4" (35mm - 51mm) thick. Supports distances from knob to door edge of 2 3/8" (60mm) to 2 3/4" (70mm). Requires a front hole of 2 1/8" (54mm) and a side hole of 1" (25.4mm).



LEVERS



ELECTRONIC

US32 US3 US5 US32D US15 US15A US11 US514

**Multiple Access Options:**

- Code (Up to 6)
- Key (3 included)

**FEATURES:**

- Durability and Security: Water-resistant and anti-tampering.
- Finish: Stainless steel.
- Access Method: Numeric code and standard key.
- Compatibility: Configurable for left or right-handed doors.
- Keypad: LED illumination for use in low-light conditions.
- Power Supply: Operates with 4 AA alkaline batteries for easy replacement.
- Door Compatibility: Suitable for wooden or metal doors 1 3/8" to 1 3/4" (35mm - 51mm) thick. Supports distances from knob to door edge of 2 3/8" (60mm) to 2 3/4" (70mm). Requires a front hole of 2 1/8" (54mm) and a side hole of 1" (25.4mm).

Electronic Handleset - Lugo Model**SINGLE CYLINDER****V160ELPLUUS15**

UPC: 871193002511

MC-6 / V-1

V160ELPLUUS514

UPC: 871193009152

MC-6 / V-1



EUROPEAN

**Multiple Access Options:**

- Code (Up to 6)
- Key (3 included)
- Remote Control **

**FEATURES:**

- Durability and Security: Anti-tampering technology and stainless steel finish, providing durability and elegance.
- Access Methods: Infrared remote control, numeric code, and standard key.
- Access Codes: 1 master code and 6 user codes ranging from 4 to 10 digits.
- Failed Attempt Lockout: Automatic lockout activates after five incorrect code attempts. Reactivates after 45 seconds.
- Automatic Locking: Automatic locking function available when activated.
- Keypad: LED illumination for use in low-light conditions.
- Power Supply: Operates with 4 AA alkaline batteries for easy replacement.
- Door Compatibility: Suitable for wooden or metal doors 1 3/8" to 1 3/4" (35mm - 51mm) thick. Supports distances from knob to door edge of 2 3/8" (60mm) to 2 3/4" (70mm). Requires a front hole of 2 1/8" (54mm) and a side hole of 1" (25.4mm).

** Also sold separately, item#: **KEYPADLOCKREMOT****Electronic Handleset - Córdoba Model****SINGLE CYLINDER****V160ECOCAUS15**

UPC: 871193000555

MC-6 / V-1



MANIJAS

**ELECTRONIC**

Electronic Handleset - Alicante Model

SINGLE CYLINDER
V160EALBAUS15
 UPC: 871193009350
 MC-6 / V-1



Multiple Access Options:

- Code (Up to 6)
- Key (3 included)
- Remote Control **



FEATURES:

- Durability and Security: Anti-tampering technology and stainless steel finish for enhanced durability and elegance.
- Access Methods: Infrared remote control, numeric code, and standard key.
- Access Codes: 1 master code and 6 user codes ranging from 4 to 10 digits.
- Failed Attempt Lockout: Activates automatic lockout after five incorrect code attempts. Reactivates after 45 seconds.
- Automatic Locking: Automatic locking function available when enabled.
- Keypad: LED illumination for convenient use in low-light conditions.
- Power Supply: Operates with 4 AA alkaline batteries for easy replacement.
- Door Compatibility: Suitable for wooden or metal doors 1 3/8" to 1 3/4" (35mm - 51mm) thick. Supports distances from knob to door edge of 2 3/8" (60mm) to 2 3/4" (70mm). Requires a front hole of 2 1/8" (54mm) and a side hole of 1" (25.4mm).

** Also sold separately, item#: **KEYPADLOCKREMOT**

Security Cameras

TVSK01D
 DOME CAMERA
 For Exterior and/or Interior Use
 UPC: 871193007110
 MC-1 / V-1



TVSK01B
 BULLET CAMERA
 For Exterior and/or Interior Use
 UPC: 871193007127
 MC-1 / V-1





Platinum

The Toledo Platinum Series offers locks with exceptional quality and durability, ideal for protecting homes with style and strength. Featuring ANSI Grade 2 certification, robust metal construction, and a design tailored for residential use, these locks ensure reliable security and elegant aesthetics for every home space.

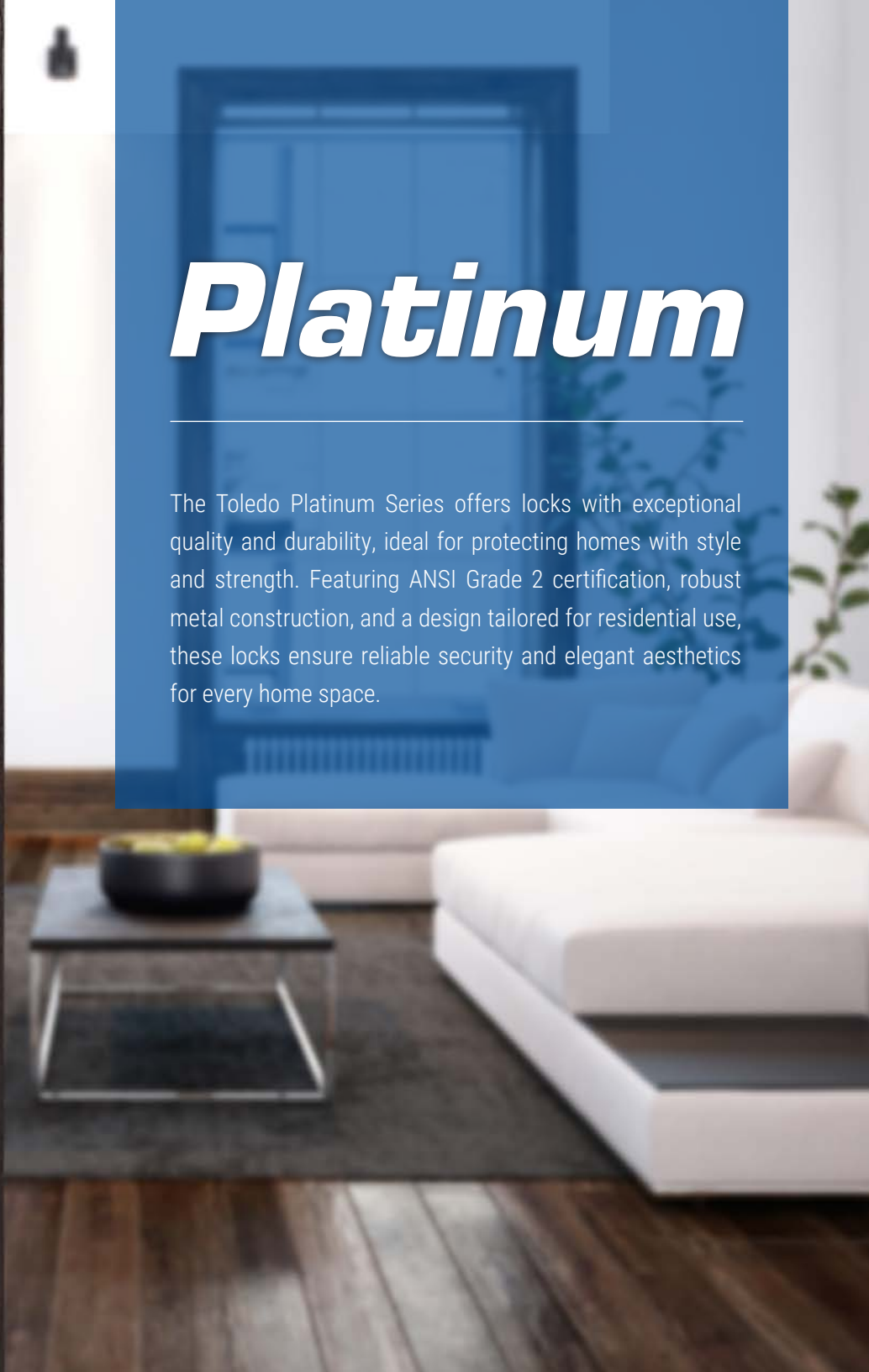

Deadbolt

SINGLE CYLINDER

CV2800-US32D

UPC: 871193000586

MC-6 / V-3

US32 US3 US5 US32D US15 US15A US11 US514

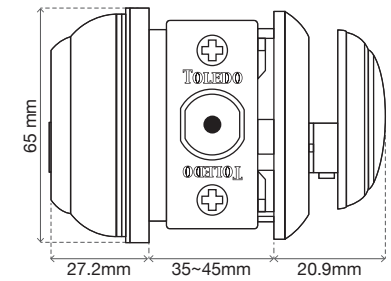

FEATURES:

- Single Cylinder
- Impact-resistant cylinder for enhanced security.
- Universal Latch: Adjustable from 2 3/8" to 2 3/4" (60mm - 70mm).
- Door Thickness: Compatible with standard thicknesses of 1 3/8" to 1 3/4" (35mm - 45mm).
- Bore Hole Depth: Adapts to configurations of 2 3/8" to 2 3/4" (60mm - 70mm).
- Faceplate: Standard square corner, 1" x 2 1/4" (25.4mm x 57mm).
- Deadbolt: Made of zinc alloy with a 1/2" nickel-plated bolt for added durability.
- Strike Plate: Square corner design, measuring 1 3/4" x 2 1/4" (44.4mm x 57mm).
- Cylinder: Standard SC1 5-pin cylinder for secure operation.

CERTIFICATIONS:

- ANSI/BHMA A156.2 2011/2017 - Grade 2 Certified.
- Complies with 30-minute fire rating. UL File No. R13776.



DEADBOLT



Platinum®

US32 US4 US5 US32D US15 US15A US11 US514



Hispania Handle - Interior Lock

PRIVACY

CV2920HIUS15

UPC: 871193001828

MC-6 / V-3

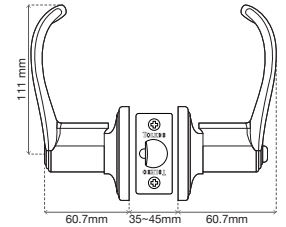

FEATURES:

- ANSI / BHMA A156.2-2003 Grade 2 Certified.
- Fire Resistance Certification: 3-hour fire rating. UL File Number R13776.
- Deadbolt: Stainless steel deadbolt with powder metallurgy construction and a 1/2" (12.7 mm) throw.
- Door Thickness: Compatible with 1-3/8" to 1-3/4" (35 mm to 45 mm) doors.
- Reversible Lever: Suitable for both right and left-handed doors.
- Latch: Square corner design, measuring 1 3/4" x 2 1/4" (44.4 mm x 57 mm).

CERTIFICATIONS:

- ANSI/BHMA A156.2 2011/2017 Grade 2 Certified.
- Complies with 30-minute fire rating. UL File No. R13776.



Zaragosa Handle - Interior Lock

PRIVACY

CV2920ZAUS15

UPC: 871193001033

MC-6 / V-3

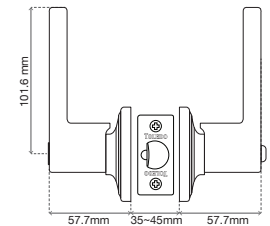

FEATURES:

- ANSI / BHMA A156.2-2003 Grade 2 Certified.
- Fire Resistance Certification: 3-hour fire rating. UL File Number R13776.
- Deadbolt: Stainless steel deadbolt with powder metallurgy construction and a 1/2" (12.7 mm) throw.
- Door Thickness: Compatible with 1-3/8" to 1-3/4" (35 mm to 45 mm) doors.
- Reversible Lever: Suitable for both right and left-handed doors.
- Latch: Square corner design, measuring 1 3/4" x 2 1/4" (44.4 mm x 57 mm).

CERTIFICATIONS:

- ANSI/BHMA A156.2 2011/2017 Grade 2 Certified.
- Complies with 30-minute fire rating. UL File No. R13776.



LEVERS



Platinum®

COMMERCIAL

Certified ANSI Grade 2 and constructed entirely of metal, the Toledo Commercial Series locks offer durability, fire resistance up to 3 hours, and ADA compliance. Designed for heavy-duty use, they are ideal for commercial environments requiring maximum security and durability.





Heavy Duty Lever

KEYED ENTRY

T-T90CUS15

UPC: 871193006045

MC-6 / V-1

PRIVACY

T-T92CUS15

UPC: 871193006052

MC-6 / V-1

STOREROOM

T-T94CUS15

UPC: 871193006069

MC-6 / V-1

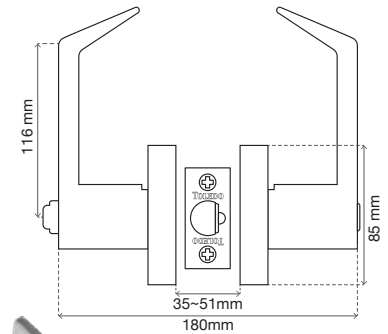

FEATURES:

- Heavy-duty and commercial application.
- All-metal construction for enhanced durability.
- Door Thickness: Standard 1 3/8" to 1 3/4" (35mm - 45mm).
- Bore Hole Depth: Fixed at 2 3/4" (70mm).
- Latch: Fixed at 2 3/4" (70mm).
- Strike Plate: Square corner measuring 1 3/4" x 2 1/4" (44.4mm x 57mm).
- Cylinder: 6-pin cylindrical, interchangeable (compatible with Best A2 SFIC).
- Fire Resistance: UL-certified for 3 hours.
- Clutch Mechanism: Vandal-resistant clutch system (T90CUS15 and T94CUS15).
- ANSI Standard: Grade 2 quality, compatible with Grade 1 features.
- Reversible Lever: Suitable for both right and left-handed doors.

CERTIFICATIONS:

- **ANSI/BHMA A156.2 2011/2017 - Grade 2**
- Complies with 30-minute fire resistance certification. UL File No. R13776
- ADA Compliant.



LEVERS



COMMERCIAL HD

Ávila Commercial Knob

KEYED ENTRY

BP900AVUS32D

UPC: 871193002269

MC-20 / V-1

STOREROOM

BP940AVUS32D

UPC: 871193002283

MC-20 / V-1

PRIVACY

BP920AVUS32D

UPC: 871193002276

MC-20 / V-1

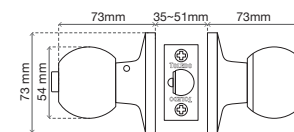

FEATURES:

- Exposed Edge: Brass or stainless steel.
- Door Thickness: Standard 1 3/8" to 1 3/4" (35mm - 45mm).
- Bore Hole Depth: Fits 2 3/8" - 2 3/4" (60mm - 70mm).
- Latch: Universal, adjustable to 2 3/8" and 2 3/4" (60mm and 70mm).
- Faceplate: Standard square corner, 1" x 2 1/4" (25.4mm x 57mm).

- Strike Plate: Square corner, 1 3/4" x 2 1/4" (44.4mm x 57mm).
- Cylinder: 6-pin, Y1 (standard). Cylinder housing made of zinc alloy with a solid brass plug.

CERTIFICATIONS:

- ANSI/BHMA A156.2 2011/2017 - Grade 2.
- Complies with 30-minute fire resistance certification. UL File No. R13776
- ADA Compliant.



Valencia Commercial Handle

KEYED ENTRY

BP900VLUS15

UPC: 871193002221

MC-10 / V-1

STOREROOM

BP940VLUS15

UPC: 871193002245

MC-10 / V-1

PRIVACY

BP920VLUS15

UPC: 871193002238

MC-10 / V-1

CLASSROOM

BP960VLUS15

UPC: 871193008056

MC-1 / V-1

HALL / CLOSET

BP910VLUS15

UPC: 871193008049

MC-10 / V-1

DOUBLE CYLINDER

BP980VLUS15

UPC: 871193002252

MC-10 / V-1

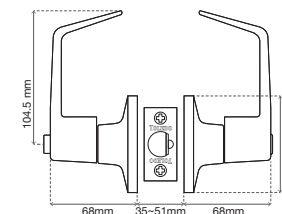

FEATURES:

- Exposed Edge: Brass or stainless steel.
- Door Thickness: Standard 1 3/8" to 1 3/4" (35mm - 45mm).
- Bore Hole Depth: Fits 2 3/8" - 2 3/4" (60mm - 70mm).
- Latch: Universal, adjustable to 2 3/8" and 2 3/4" (60mm and 70mm).
- Faceplate: Standard square corner, 1" x 2 1/4" (25.4mm x 57mm).

- Strike Plate: Square corner, 1 3/4" x 2 1/4" (44.4mm x 57mm).
- Cylinder: 6-pin, Y1 (standard). Cylinder housing made of zinc alloy with a solid brass plug.
- Reversible Lever: Suitable for both right and left-handed doors.

CERTIFICATIONS:

- ANSI/BHMA A156.2 2011/2017 - Grade 2.
- Complies with 30-minute fire resistance certification. UL File No. R13776
- ADA Compliant.



KNOB Y LEVERS



COMMERCIAL

US32 US3 US5 US32D US15 US15A US11 US514



Commercial Deadbolt

SINGLE CYLINDER

BP800US32D

UPC: 871193002955

MC-20 / V-1

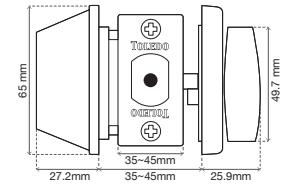

FEATURES:

- Exposed Edge: Brass or stainless steel.
- Door Thickness: Standard 1 3/8" to 1 3/4" (35mm - 45mm).
- Bore Hole Depth: Fits 2 3/8" - 2 3/4" (60mm - 70mm).
- Latch: Universal, adjustable to 2 3/8" and 2 3/4" (60mm and 70mm).
- Faceplate: Standard square corner, 1" x 2 1/4" (25.4mm x 57mm).
- Retention Bolt: Brass bolt with a hardened steel insert rod, full 1" (25.4mm) throw.
- Bolt: Square corner, 1 3/4" x 2 1/4" (44.4mm x 57mm).
- Cylinder: 6-pin, Y1 (standard). Cylinder housing made of zinc alloy with a solid brass plug.

CERTIFICATIONS:

- ANSI/BHMA A156.2 2011/2017 - Grade 2.
- Complies with 30-minute fire resistance certification. UL File No. R13776
- ADA Compliant.



Commercial Deadbolt

DOUBLE CYLINDER

BP801US32D

UPC: 871193002955

MC-20 / V-1

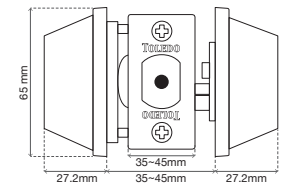

FEATURES:

- Exposed Edge: Brass or stainless steel.
- Door Thickness: Standard 1 3/8" to 1 3/4" (35mm - 45mm).
- Bore Hole Depth: Fits 2 3/8" - 2 3/4" (60mm - 70mm).
- Latch: Universal, adjustable to 2 3/8" and 2 3/4" (60mm and 70mm).
- Faceplate: Standard square corner, 1" x 2 1/4" (25.4mm x 57mm).
- Retention Bolt: Brass bolt with a hardened steel insert rod, full 1" (25.4mm) throw.
- Bolt: Square corner, 1 3/4" x 2 1/4" (44.4mm x 57mm).
- Cylinder: 6-pin, Y1 (standard). Cylinder housing made of zinc alloy with a solid brass plug.

CERTIFICATIONS:

- ANSI/BHMA A156.2 2011/2017 - Grade 2.
- Complies with 30-minute fire resistance certification. UL File No. R13776



DEADBOLTS



COMMERCIAL

*Barn*door HARDWARE

Our sliding door hardware blends rustic design with modern functionality to complement any space. Made from durable materials and finished with elegant details, this hardware is ideal for adding a distinctive and sturdy touch to any sliding door.



Aluminum Barndoor Kit / T-Shape Design

TBDT007SS

Satin Nickel

Weight Capacity: 330 lbs

Door Thickness: 1 3/8" to 1 3/4"

UPC: 810055042456

MC-1 / V-1

TBDT007B

Matte Black

Weight Capacity: 330 lbs

Door Thickness: 1 3/8" to 1 3/4"

UPC: 810055042449

MC-1 / V-1



Aluminum Barndoor Kit / J-Shape Design

TBDJ005SS

Satin Nickel

Weight Capacity: 330 lbs

Door Thickness: 1 3/8" to 1 3/4"

UPC: 810055042432

MC-1 / V-1

TBDJ005B

Matte Black

Weight Capacity: 330 lbs

Door Thickness: 1 3/8" to 1 3/4"

UPC: 810055042425

MC-1 / V-1



Barndoor Extension Kit with Rail

TBDE 24 SN

Aluminum and Steel
Satin Nickel

24"

UPC: 810055044276

MC-10 / V-1



TBDE 24 MB

Aluminum and Steel
Matte Black

24"

UPC: 810055044269

MC-10 / V-1



Barndoor Lever

TBDHKSS

304 Stainless Steel
UPC: 810055044177

MC-24 / V-8

TBDHKMB

304 Stainless Steel
Matte Black

UPC: 810055044184

MC-24 / V-8



Solid STAINLESS STEEL

Crafted from solid 304 stainless steel alloy and available in various finishes, our mortise locks, cylinders, plates, and handles deliver security and style to suit any project. This category also includes the Black Series, designed for high-security needs and superior quality, providing maximum protection and confidence in every installation.



Handles

TH002

20" | 50.8 cm

UPC: 871193001897

MC-10 / V-1

TH002-3

36" | 91.44 cm

UPC: 810055041060

MC-10 / V-1

TH002-6

72" | 182.88 cm

UPC: 871193004621

MC-5 / V-1

**TH031-3**

36" | 91.44cm

UPC: 871193004836

MC-10 / V-1

TH031-3EB

36" | 91.44cm

Black MATE

UPC: 871193009817

MC-10 / V-1



Base con ángulo de 45°

TH090-3

36" | 91.44cm

UPC: 871193004843

MC-5 / V-1

TH090-3EB

36" | 91.44 cm

Black MATE

UPC: 871193009824

MC-5 / V-1

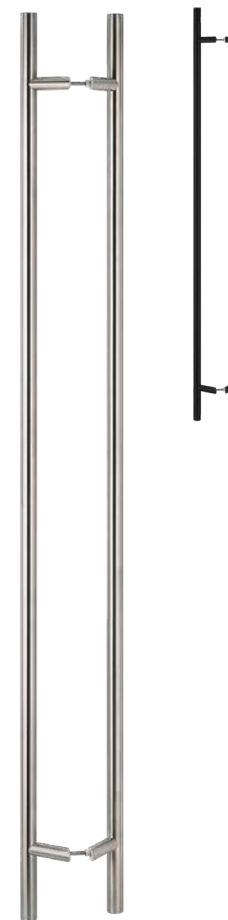

SOLID STAINLESS STEEL 304 / HANDLES

Fine Locks®

Mortise Lock with Cylinder Plate Combo

TML020

304 Stainless Steel
Security Keys
UPC: 871193007776
MC-20 / V-1

TML020EB

304 Stainless Steel
Matte Black
Security Keys
UPC: 810055041121
MC-20 / V-1



Mortise Lock with Handle Plate Combo

TML110

304 Stainless Steel
Security Keys
UPC: 871193007769
MC-10 / V-1

TML110D (Dummy)

304 Stainless Steel
Security Keys
UPC: 871193006137
MC-20 / V-1



Mortise Lock with Handle Combo

TML100

304 Stainless Steel
Security Keys
UPC: 871193007752
MC-10 / V-1



Recessed Window Lock Combo

TWM3542

35x85mm
304 Stainless Steel
Standard Key
UPC: 871193009688
MC-25 / V-1

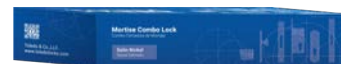

MORTISE LOCKS COMBOS



Fine Locks®

Mortise Lock Plates

TF001S

UPC: 871193001422

MC-20 / V-1

COMBO OPTION

TF001S-COMBOS

V-1

**TF060S**

UPC: 871193001446

MC-20 / V-1

COMBO OPTION

TF060S-COMBOS

V-1

**TD060E**

UPC: 871193004645

MC-20 / V-1

COMBO OPTION

TD060E-COMBOS

V-1

**TD002BD**

UPC: 871193004300

MC-20 / V-1

COMBO OPTION

TD002BD/COMBOS

V-1

TD002BD-EB

Matte Black

UPC: 871193009879

MC-20 / V-1

COMBO OPTIONS

TD002BD-EB-COMBOS

Matte Black

V-1

**46A**

UPC: 871193004799

MC-60 / V-1

**36A**

UPC: 871193001224

MC-200 / V-1

36A-EB

Matte Black

UPC: 871193009862

MC-200 / V-1



Lock Plate for Dummy Lock

THC01

UPC: 871193009671

MC-1 / V-1



High-Security Handle

TSCP004

Without Packaging

UPC: 871193004744

MC-120 / V-1



SOLID STAINLESS STEEL 304 / PLATES

Fine Locks®

Double Cylinder

202DD/CD

70mm
Standard Key
UPC: 871193006021
MC-50 / V-1

V202D/C

70mm
Standard Key
UPC: 871193009398
MC-48 / V-1



Single Cylinder

202DD

70mm
Standard Key
UPC: 871193001613
MC-50 / V-1

V202DD

70mm
Standard Key
UPC: 871193009725
MC-48 / V-1



Double Cylinder

202DD/C

70mm
Security Keys
UPC: 871193001606
MC-50 / V-1

V202DD/C

70mm
Security Keys
UPC: 810055041084
MC-48 / V-1

202DD/C-EB

70mm
Matte Black
Security Keys
UPC: 871193009848
MC-50 / V-1



Privacy / Bedroom - Bathroom

BK804

70mm
UPC: 871193001200
MC-40 / V-1



Half Cylinder

201D

40mm
Standard Key
UPC: 871193004775
MC-50 / V-1-



Mortise Locks

VS358501

35x85mm
Satin Nickel
UPC: 871193009664
MC-30 / V-1

**4585**

35x85mm
Satin Nickel
UPC: 871193001590
MC-25 / V-1

4585EB

35x85mm
Matte Black
UPC: 871193009855
MC-25 / V-1

TF6072

60x72mm
Satin Nickel
UPC: 871193004607
MC-20 / V-1

T0225

22.5mm
Satin Nickel
UPC: 871193002214
MC-48 / V-1

**BK55A**

55mm
Satin Nickel
UPC: 871193001217
MC-40 / V-1



MORTISE LOCKS



Fine Locks®

Lock with Hook Bolt

T703

UPC: 871193001491

MC-12 / V-1



T703A

UPC: 871193001774

MC-1 / V-1



Lock with Long Bolt

T713

UPC: 871193001501

MC-12 / V-1



T714

DOUBLE CYLINDER

UPC: 871193001705

MC-1 / V-1



Cylinders

CYL702

SINGLE CYLINDER

UPC: 871193004812

MC-60 / V-1



CYL702EB

SINGLE CYLINDER

Matte Black

UPC: 810055044818

MC-60 / V-1

CYL703

DOUBLE CYLINDER

UPC: 871193001781

MC-60 / V-1



CYL703EB

DOUBLE CYLINDER

Matte Black

UPC: 810055043873

MC-60 / V-1

MORTISE LOCKS



Fine Locks

Double Cylinder Mortise Lock

TBKCYL703

UPC: 871193007875

MC-60 / V-1



High-Security Cylinder

TBK96AHS

Anti-Cut

Anti-Pry

Anti-Drill

UPC: 871193006755

MC-24 / V-1



Hook Bolt Lock

TBK703

Backset 11/8

UPC: 871193007868

MC-24 / V-1



TBK705

Backset 11/2

UPC: 871193009756

MC-24 / V-1



Long Bolt Lock

TBK714

UPC: 871193009756

MC-24 / V-1



HIGH-SECURITY MORTISE LOCKS



Black Series

Gate LOCKS

Reliable security for outdoor spaces. With a variety of models and finishes, these locks adapt to any installation style, providing a solid and functional aesthetic.



Surface-Mounted Lock

T010R

Right-Hand Function
50mm
UPC: 871193007493
MC-24 / V-6

T010L

Left-Hand Function
50mm
UPC: 871193007486
MC-24 / V-1

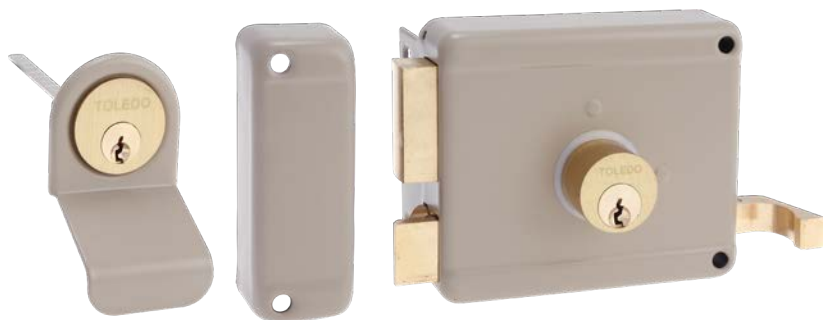

T011R

Right-Hand Function
60mm
UPC: 871193001682
MC-24 / V-1

T011L

Left-Hand Function
60mm
UPC: 871193001699
MC-24 / V-1



Jimmy Proof

TJ-601

SINGLE CYLINDER
UPC: 871193001361
MC-1 / V-3

TJ-602

DOUBLE CYLINDER
UPC: 871193001378
MC-24 / V-3

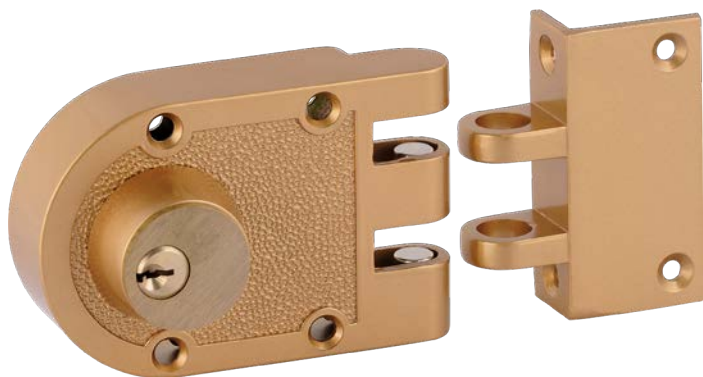

Metal Box for Gate Deadbolt

TSB01

White Box Packaging
UPC: 871193009220
MC-48 / V-1



Deadbolts with Metal Box

Latch Bolt / Hidden Screw

-  **T315US32D**
UPC: 871193006625
MC-1 / V-3



Deadbolt Latch / Hidden Screws

-  **T313US5**
UPC: 871193002382
MC-24 / V-3
-  **T313US11**
UPC: 871193004867
MC-24 / V-3
-  **T313US32D**
UPC: 871193001880
MC-24 / V-3
-  **T313US514**
UPC: 810055044009
MC-24 / V-3



Deadbolt with Hidden Screws

-  **T314US5**
UPC: 871193004881
MC-24 / V-6
-  **T314US11**
UPC: 871193004874
MC-24 / V-6
-  **T314US32D**
UPC: 871193005208
MC-24 / V-6
-  **T314US514**
UPC: 810055044016
MC-24 / V-6



Gate Lock Combo with Metal Box

-  **TLCL313US5**
UPC: 871193005451
MC-6 / V-1
-  **TLCL313US11**
UPC: 871193005468
MC-6 / V-1
-  **TLCL313US32D**
UPC: 871193005444
MC-6 / V-1
-  **TLCL313US514**
UPC: 810055044153
MC-6 / V-1





STRONGHOLD **PADLOCKS**

Stronghold padlocks are designed to meet a wide range of security needs, offering options from durable stainless steel and weather-resistant models to versatile Aluminum and combination locks. Engineered for reliability and strength, Stronghold padlocks deliver trusted protection for what matters most, no matter the circumstance.

Laminated Padlocks



L30

31.75 x 50.73 x 20mm
 UPC: 871193000982
 MC-72 / V-6

L40

41.28 x 59.25 x 26mm
 UPC: 871193000999
 MC-72 / V-6

L50

51 x 68.5 x 30mm
 UPC: 871193001019
 MC-60 / V-6

L50L

51 x 97 x 30mm
 UPC: 871193001026
 MC-48 / V-6

L60

65 x 73.5 x 31mm
 UPC: 871193009718
 MC-48 / V-6

L40

L40KA2
 UPC: 871193001743
 MC-36 / V-6

L40KA4

UPC: 871193001750
 MC-18 / V-6

L50

L50KA
 UPC: 871193001736
 MC-144 / V-12

L50KA2
 UPC: 871193001040
 MC-36 / V-6

L50KA4
 UPC: 871193001057
 MC-16 / V-4

L50KA6
 UPC: 871193001712
 MC-6 / V-1

L50KA12
 UPC: 871193001729
 MC-72 / V-1

L50LKA2
 UPC: 871193001064
 MC-36 / V-6



Reinforced Steel Shackle

Double Locking System

Laminated Steel Body

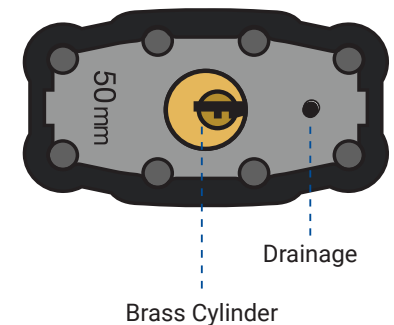

Drainage

Brass Cylinder

FEATURES:

- **Body Material:** Laminated steel body protected by a plastic coating for enhanced impact and wear resistance.
- **Cylinder Material:** Anti-corrosion brass cylinder designed for smooth operation and increased durability.
- **Security Shackle:** Hardened steel shackle provides high resistance against cutting and sawing.
- **Security System:** Double locking system with a 4-pin mechanism for enhanced security and tamper resistance.
- **Keys Included:** Includes 3 high-quality brass keys for easy use.

RECOMMENDED USES: Ideal for securing properties in high-traffic areas, such as doors, gates, toolboxes, and other access points requiring high levels of security and wear resistance.



LAMINATED PADLOCKS



STRONGHOLD

Brass Padlocks

TO18KA2

18 x 39.5 x 11.5mm
UPC: 871193002719
MC-72 / V-6

TO20

21 x 35 x 13mm
UPC: 871193000708
MC-72 / V-6

TO25

25 x 37.5 x 13mm
UPC: 871193000715
MC-72 / V-6

TO30

30 x 46 x 14mm
UPC: 871193000722
MC-60 / V-6

TO40

40 x 56.5 x 16mm
UPC: 871193000739
MC-60 / V-6

TO40L

40 x 71.2 x 16mm
UPC: 871193005109
MC-48 / V-6

TO50

49 x 68 x 17mm
UPC: 871193000746
MC-60 / V-6

TO50L

49 x 82.4 x 17mm
UPC: 871193000777
MC-48 / V-6

TO60

60 x 86.5 x 20mm
UPC: 871193000753
MC-60 / V-6

TO60L

60 x 106 x 20mm
UPC: 871193005093
MC-48 / V-6

TO70

70 x 88.1 x 20mm
UPC: 871193000760
MC-48 / V-6

TO40

TO40KA2

UPC: 871193002054
MC-36 / V-6

TO40KA3

UPC: 871193002061
MC-24 / V-6

TO40KA4

UPC: 871193002078
MC-18 / V-6

TO40LKA2

UPC: 871193005116
MC-36 / V-6

TO50

TO50KA

UPC: 871193002092
MC-72 / V-12

TO50KA2

UPC: 871193000784
MC-36 / V-6

TO50KA3

UPC: 871193002085
MC-24 / V-6

TO50KA4

UPC: 871193000791
MC-16 / V-4

TO50KA6

UPC: 999999002099
MC-36 / V-1

TO50KA12

UPC: 871193002023
MC-48 / V-1

TO50LKA144

UPC: 871193005659
MC-72 / V-12

TO50LKA2

UPC: 871193002115
MC-36 / V-6

TO60

TO60KA

UPC: 999998002090
MC-72 / V-12

TO60KA2

UPC: 871193002030
MC-36 / V-6

TO60KA6

UPC: 871193002047
MC-6 / V-1

TO60KA12

UPC: 871193002108
MC-48 / V-1

TO60LKA2

UPC: 871193005499
MC-36 / V-6

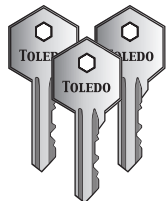

Reinforced Steel Shackle

Double Locking System

Solid Brass Body

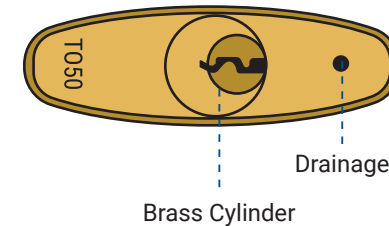

Drainage

Brass Cylinder

FEATURES:

- **Material:** Brass body and hardened steel shackle combining weather resistance with high cut protection.
- **Durable Shackle:** High-strength shackle designed to withstand cutting and twisting attempts, with an anti-corrosion coating for added durability.
- **Locking Mechanism:** Precision double-locking cylinder system, providing an extra layer of protection against tampering.
- **Keys Included:** 3 high-quality keys, designed for durable and reliable use.

RECOMMENDED USES:

Ideal for securing residential and commercial areas, such as doors, gates, toolboxes, lockers, fences, and more.



NAUTICAL Stainless Steel Padlock



TO30N

32 x 45.6 x 13.5mm
 UPC: 871193005826
 MC-60 / V-6

TO40N

38 x 55.4 x 15mm
 UPC: 871193005833
 MC-60 / V-6

TO40NL

38 x 55.4 x 15mm
 UPC: 810055044320
 MC-48 / V-6

TO50N

50 x 67 x 18mm
 UPC: 871193005840
 MC-60 / V-6

TO50NKA2

50 x 67 x 18mm
 UPC: 810055044344
 MC-72 / V-6

TO50NL

50 x 67 x 18mm
 UPC: 810055044337
 MC-48 / V-6

TO60

60 x 67 x 18mm
 UPC: 810055044351
 MC-48 / V-6



Stainless Steel Shackle

Double Locking System

Stainless Steel Body

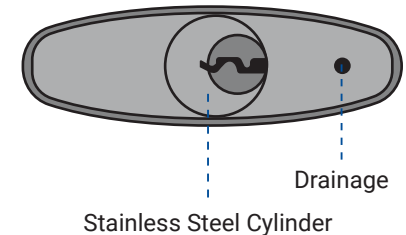

FEATURES:

- **Body Material:** High-quality stainless steel.
- **Shackle Material:** Corrosion-resistant stainless steel.
- **Locking System:** Precision double-locking mechanism.
- **Keys Included:** 3 high-quality keys, designed for durable and reliable use.

RECOMMENDED USES:

Ideal for securing boats, marine equipment, coastal properties, businesses, and residences in humid areas or regions exposed to harsh weather conditions. Its durable design makes it an excellent choice for outdoor applications requiring extra protection against corrosion and the elements.

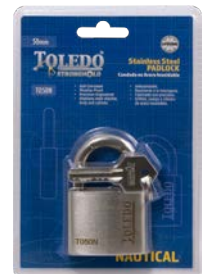

Aluminum Padlock



TBK90AL

38 x 78 x 19mm

TBK90AL-RED

UPC: 871193005864

MC-72 / V-6

TBK90AL-GREEN

UPC: 871193006090

MC-72 / V-6

TBK90AL-BLUE

UPC: 871193006106

MC-72 / V-6

TBK92AL

38 x 104 x 19mm

TBK92AL-RED

UPC: 871193006151

MC-72 / V-6

TBK92AL-GREEN

UPC: 871193006144

MC-72 / V-6

TBK92AL-BLUE

UPC: 871193005871

MC-72 / V-6

TBK200AL

50 x 83 x 19mm

TBK200AL-RED

UPC: 871193005888

MC-72 / V-6

TBK200AL-GREEN

UPC: 871193006199

MC-72 / V-6

TBK200AL-BLUE

UPC: 871193006205

MC-72 / V-6

TBK202AL

50 x 108 x 19mm

TBK202AL-RED

UPC: 871193005895

MC-72 / V-6

TBK202AL-GREEN

UPC: 871193006250

MC-72 / V-6

TBK202AL-BLUE

UPC: 871193006250

MC-72 / V-6



Reinforced Steel Shackle

Double Locking System

Aluminum Body

Anti-Bump Cylinder

Anti-Pry

Anti-Drill



Drainage

Brass Cylinder

* Pregunte por nuestros servicios de igualación.

FEATURES:

- **Body Material:** Solid aluminum, corrosion-resistant, ideal for all weather conditions.
- **Quick-Change Shackle:** Hardened steel shackle with a quick-change design for easy replacement and maximum durability.
- **Brass Cylinder:** 6-pin rekeyable cylinder, resistant to bumping and drilling, easily customizable for keying alike.
- **Security Mechanism:** Double ball-bearing locking system resists prying, enhancing security.
- **Keys Included:** Includes 2 high-quality keys, designed for durability and reliability.

RECOMMENDED USES: Perfect for securing electrical boxes, doors, cabinets, lockers, and other applications requiring a secure, weather-resistant padlock with advanced protection against tampering techniques.

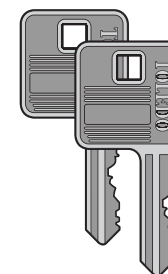

ALUMINUM PADLOCKS



STRONGHOLD

Solid Steel Security Padlock

TOS350S

50 x 96.5 x 20mm
 UPC: 871193003037
 MC-36 / V-6

TOS360S

60 x 109.1 x 20mm
 UPC: 871193003044
 MC-36 / V-6

TOS450S

50 x 80 x 23mm
 UPC: 871193003051
 MC-36 / V-6

TOS450S

60 x 94 x 25mm
 UPC: 871193003068
 MC-36 / V-6



FEATURES:

- **Body Material:** One-piece steel construction maximizes durability and strength.
- **Shackle Material:** High-strength hardened steel, designed to withstand cutting attempts.
- **Locking System:** Brass cylinder with an 8-disc security mechanism.
- **Keys Included:** Comes with 4 security keys featuring a key-retention function, ensuring the keys can only be removed when the padlock is in the locked position, preventing accidental unsecured situations.

RECOMMENDED USES: Ideal for securing properties, warehouses, gates, and other high-value or high-risk areas requiring superior and long-lasting protection.

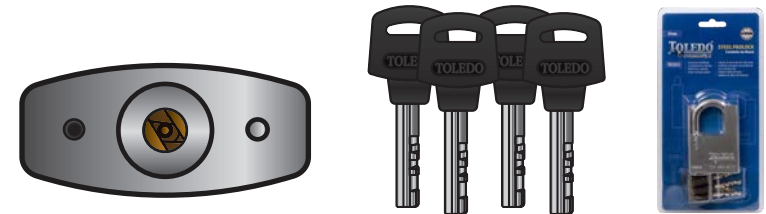

Solid Steel Security Padlock

TS65

65 X 85.6 X 28mm
 UPC: 871193005147
 MC-12 / V-6



FEATURES:

- **Body Material:** Solid high-quality steel for maximum durability and resistance in demanding security applications.
- **Cylinder Material:** Brass cylinder with a 6-disc system, enhancing security and preventing unauthorized tampering.
- **Security Shackle:** Designed to resist cutting and sawing, providing reinforced protection against tool-based attacks.
- **Keys Included:** Comes with 4 security keys featuring a key-retention function, ensuring keys can only be removed when the padlock is in the locked position, preventing accidental unsecured situations.

RECOMMENDED USES: Ideal for securing gates, warehouses, and other areas requiring robust and reliable protection against unauthorized access.

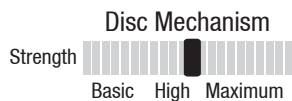
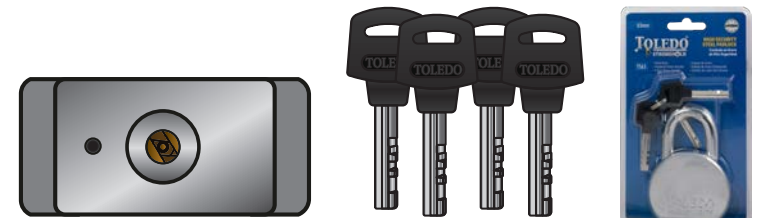

PADLOCKS



STRONGHOLD

Waterproof Padlock with PVC-Coated Iron Body

MS5740

46.7 x 71.3 x 25.7mm
 UPC: 810055041145
 MC-36 / V-6

MS5750

59.5 x 85.2 x 31.7mm
 UPC: 810055041152
 MC-36 / V-6

MS57450L

59.5 x 112.3 x 31.7mm
 UPC: 810055041169
 MC-36 / V-6



FEATURES:

- **Body Material:** PVC-coated iron for maximum weather resistance and water protection.
- **Shackle Material:** PVC-coated hardened steel, designed to resist cutting and tool attacks.
- **Brass Cylinder:** High-precision, corrosion-resistant cylinder.
- **Locking System:** 6-pin mechanism with double locking for maximum security.
- **Keys Included:** Includes 3 high-precision security keys.

RECOMMENDED USES: Ideal for securing gates, cabinets, sheds, and other outdoor applications or areas exposed to moisture and harsh weather conditions, providing reliable protection against water and rust.

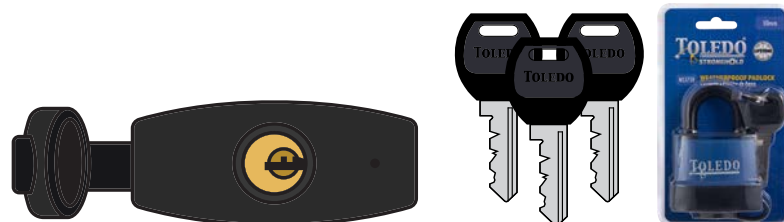

Maximum Security Rainproof Padlock

TW50B

50 x 28.3 x 23.5mm
 UPC: 871193005154
 MC-24 / V-6

TW60B

61.5 x 78 x 25.5mm
 UPC: 871193005161
 MC-24 / V-6



FEATURES:

- **Shackle Material:** Hardened steel resistant to cutting.
- **Locking Mechanism:** Stainless steel ball system for maximum security.
- **High-Security Cylinder:** Brass cylinder with 6 discs, resistant to tampering and drilling techniques.
- **Finish:** Corrosion-resistant, ideal for humid and outdoor conditions.
- **Keys Included:** Comes with 4 security keys featuring a key-retention function, ensuring the keys can only be removed when the padlock is in the locked position, preventing accidental unsecured situations.

RECOMMENDED USES: Ideal for securing gates, warehouses, sheds, work equipment, and other outdoor applications, providing robust protection against corrosion and tampering techniques.

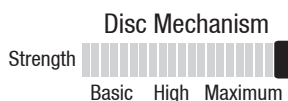
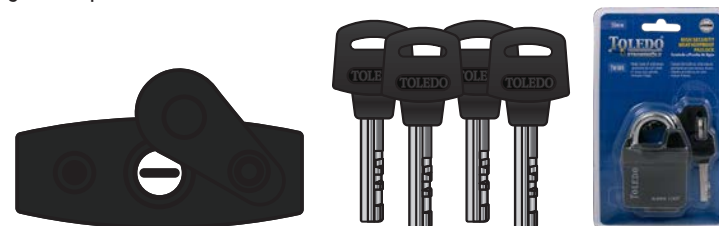

Maximum Security Solid Brass Padlock

TS75

75 X 55.6 X 20mm
 UPC: 871193005123
 MC-24 / V-6

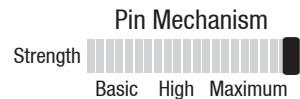

FEATURES:

- **Body Material:** Solid brass, corrosion-resistant, providing durability and a professional finish.
- **Security Shackle:** Hardened steel shackle designed to resist cutting and protect the padlock from forced tampering.
- **Brass Cylinder:** Durable brass cylinder offering consistent performance and resistance in high-humidity environments.
- **Pin System:** Pin mechanism optimized for enhanced security, making unauthorized access more difficult.

RECOMMENDED USES: Ideal for high-strength security applications such as containers, warehouses, industrial gates, fences, toolboxes, and trailers, offering robust protection against tampering and extreme conditions.



High-Security Stainless Steel Padlock

TR70

70 x 38.5 x 30mm
 UPC: 871193005130
 MC-24 / V-6

TR70KA2

70 x 38.5 x 30mm
 UPC: 871193006953
 MC-12 / V-3

TR70KA4

70 x 38.5 x 30mm
 UPC: 810055041114
 MC-8 / V-4

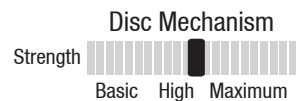

FEATURES:

- **Body Material:** High-durability stainless steel, ideal for outdoor use.
- **Security Shackle:** Hardened stainless steel shackle for added resistance against cutting and sawing.
- **Brass Cylinder:** Precision brass cylinder offering smooth and long-lasting performance.
- **Pin Security System:** Pin mechanism ensures advanced protection against tampering.
- **Double Locking:** Reinforced locking system for enhanced protection against force attacks.

RECOMMENDED USES: Ideal for securing containers, gates, toolboxes, fences, and other outdoor security applications, providing an optimal combination of weather resistance and high security against tampering attempts.



PADLOCKS



STRONGHOLD

TSA-Approved Luggage Padlock

TBK04

50 x 43 x 20mm

UPC: 871193005260

MC-36 / V-6



FEATURES:

- **Combination System:** 3 dials with 1,000 possible combinations.
- **Security Window:** Green/red color indicator to signal TSA access.
- **TSA Approval:** Complies with Transportation Security Administration standards, ideal for international travel.

RECOMMENDED USES: This padlock is perfect for securing suitcases, backpacks, and other luggage during travel. Its TSA approval and practical design make it ideal for frequent travelers seeking reliable protection without the worry of damage during security inspections.



Combination Padlock

TCO50

28 x 63 x 13mm

UPC: 871193004911

MC-72 / V-6



FEATURES:

- **Sistema de Combinación:** 3 dígitos, con 1,500 combinaciones posibles.
- **Material del Grillete:** Steel endurecido resistente a cortes.
- **Tamaño del Cuerpo:** 1-7/8" de ancho (48 mm).
- **Material del Cuerpo:** Steel y Aluminum de doble blindaje para máxima resistencia.

USOS RECOMENDADOS: Perfecto para asegurar casilleros, puertas de almacenes, rejas, y otras áreas que requieran un acceso seguro y controlado. Su diseño compacto y duradero lo hace ideal tanto para aplicaciones en interiores como exteriores, donde se necesite una seguridad cómoda y sin llave.





Black Series **PADLOCKS**

Designed to meet the most demanding security needs, Black Series padlocks are ideal for protecting commercial properties, industrial areas, warehouses, fences, and any space exposed to extreme conditions. Reliable, durable, and robust, Black Series is the perfect choice when security is non-negotiable.

High-Security Stainless Steel Padlocks

TBK840

40mm

Body Dimensions: 39.88 x 46.4 x 20.32 mm

Shackle Clearance: 19.8 x 26.08 mm

Shackle Diameter: 9.5 mm

UPC: 810055044023

MC-16 / V-2

TBK850P

50mm

Body Dimensions: 50.8 x 78.8 x 25.4 mm

Shackle Clearance: 19.75 x 25.02 mm

Shackle Diameter: 6.35 mm

UPC: 810055044030

MC-24 / V-2

FEATURES:

- Replaceable brass cylinder with 6 pins.
- Resistant to bumping, picking, and drilling.
- Double locking system with stainless steel balls.
- Intelligent shackle change design.
Registered Patent
- Designed for marine and coastal environments, ideal for boats, cargo containers, beach huts, and more.
- Includes two keys.

* Ask about our keying services.

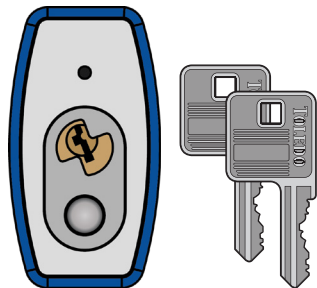

MAXIMUM SECURITY PADLOCKS



Black Series

Laminated Security Padlock

TBKL50

44mm
49 x 37 x 28 mm
UPC: 871193007790
MC-36 / V-6

TBKL50L

44mm
49 x 37 x 28 mm
UPC: 871193007806
MC-36 / V-6

TBKL60

50mm
55 x 107 x 31 mm
UPC: 871193007813
MC-36 / V-6



FEATURES:

- Resistant to cutting, picking, and drilling.
- Padlock body with high-quality plating.
- Shackle made of molybdenum alloy, highly resistant.
- Reinforced brass cylinder resistant to cutting, picking, and drilling.
- High-quality ABS cover to protect the padlock surface.
- Double locking system with stainless steel rotating balls.
- Includes two keys.



Weather-Resistant Laminated Security Padlock

TBK50JR

53mm
53 x 44 x 32 mm
UPC: 871193007820
MC-36 / V-6

TBK50JRL

53mm
53 x 44 x 32 mm
UPC: 871193007844
MC-36 / V-6

TBK60JR

59mm
59 x 47.5 x 35 mm
UPC: 871193007837
MC-36 / V-6



FEATURES:

- Resistant to cutting, picking, and drilling.
- Padlock body with high-quality plating.
- Shackle made of molybdenum alloy, highly resistant.
- Reinforced brass cylinder resistant to cutting, picking, and drilling.
- High-quality ABS cover to protect the padlock surface.
- Double locking system with stainless steel rotating balls.
- Stainless steel flip cover for added protection.
- Includes two keys.

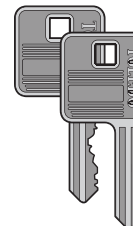

* Ask about our keying services.

MAXIMUM SECURITY PADLOCKS



Black Series

Maximum Security Laminated Padlock

TBK12

44 mm
44 x 47 x 27 mm
UPC: 871193005239
MC-16 / V-4

TBK14

63 mm
63 x 52 x 31 mm
UPC: 871193005253
MC-12 / V-4

TBK13

50 mm
50 x 47 x 30 mm
UPC: 871193005246
MC-16 / V-4

TBK13-KA2

50 mm
50 x 47 x 30 mm
UPC: 871193005550
MC-8 / V-4



FEATURES:

- Resistant to cutting, picking, drilling, and impact.
- Molybdenum shackle with high cutting resistance.
- Coated with baked electrostatic paint for greater durability and protection.
- Anti-impact protection.
- Locking system with rotating balls for enhanced security.
- UV-sealed shackle designed to prevent water ingress.
- Includes two keys.



Super Duty Solid Steel Padlock

TBK90R

63.5 mm
63.5 x 57 x 27 mm
UPC: 871193005314
MC-16 / V-4

TBK90RKA2

63.5 mm
63.5 x 57 x 27 mm
Dos Candados Iguales
UPC: 871193005567
MC-8 / V-2

TBK92R

63.5 mm
63.5 x 57 x 27 mm
UPC: 871193005321
MC-16 / V-4



FEATURES:

- Resistant to cutting, picking, and drilling.
- Double stainless steel ball locking system for maximum security.
- Molybdenum shackle with high cutting resistance.
- Solid hardened steel body for greater durability.
- Includes two keys.

* Ask about our keying services.



MAXIMUM SECURITY PADLOCKS



Black Series

Brass Security Padlocks

TBK50HD

50mm
50 x 46 x 18.6 mm
UPC: 871193006403
MC-16 / V-4

TBK60HD

60mm
60 x 52 x 19 mm
UPC: 871193006410
MC-16 / V-4

TBK70HD

70mm
70 x 62 x 21 mm
UPC: 871193006427
MC-16 / V-4



FEATURES:

- Resistant to cutting, picking, and drilling.
- Molybdenum shackle highly resistant to cutting.
- Solid brass body for maximum durability.
- Brass cylinder with 6 interchangeable pins, includes two keys.
- Locking system with rotating balls for enhanced security.
- Includes screw set for key-retention option.
- Includes two keys.

* Ask about our keying services.



Brass Combination Padlock with Resettable Combination

TBK50RC

50 mm
50 x 42 x 23 mm
UPC: 871193007783
MC-36 / V-6



FEATURES:

- Lock body and components made of durable brass.
- 4 dials with 10,000 possible combinations.
- Easy combination reset.
- Watertight shackle closure to prevent water ingress.
- Molybdenum shackle highly resistant to cutting.
- UV-sealed shackle for maximum water resistance and durability.



MAXIMUM SECURITY PADLOCKS



Black Series

Super Duty Solid Steel Padlock

TBK400

73 mm
73 x 73 x 38 mm
UPC: 871193005222
MC-16 / V-2



FEATURES:

- Resistant to cutting, picking, and drilling.
- Hardened steel body with a high-quality black finish.
- Hardened steel shackle, highly resistant to cutting.
- 6-pin interchangeable cylinder for enhanced security.
- Includes two keys.

* Ask about our keying services.

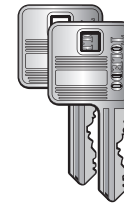
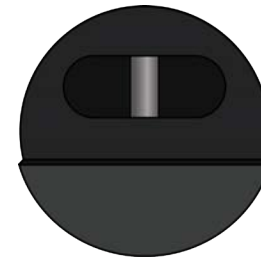

Super Duty Solid Steel Padlock with Hasp

TBK64S

73 mm
73 x 73 x 38 mm
UPC: 871193005215
MC-6 / V-1



FEATURES:

- Resistant to cutting, picking, and drilling.
- Hardened steel body with a high-quality black finish.
- Hardened steel shackle, designed to resist cutting.
- 6-pin interchangeable cylinder for enhanced security.
- Ideal for securing doors, commercial vehicles, and outdoor spaces, thanks to its high-security hasp providing maximum protection.
- Includes two keys.

* Ask about our keying services.

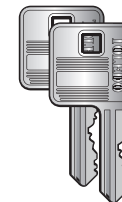
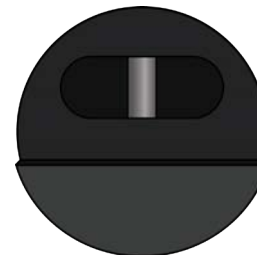

MAXIMUM SECURITY PADLOCKS



Black Series

Window **HARDWARE**

Toledo window hardware, crafted from high-quality materials, provides durable and functional solutions for all types of windows. Designed to ensure reliable performance and security, all our



Window Operator - French Style Window

TWHW7RANRA63.5W

● White
 UPC: 871193005079
 MC-40 / V-10



TWHW7RANRA63.5B

● Bronze
 UPC: 871193006748
 MC-40 / V-10



TWHW7LANRA63.5W

Left-Hand Function
 ● White
 UPC: 871193003822
 MC-40 / V-10

TWHW7RANRA64.0WH *

● White
 UPC: 871193006816
 MC-40 / V-10



Window Operator - French Style Window

TWHW7RANRA68WH

● White
 UPC: 871193005765
 MC-40 / V-10



Window Operator - French Style Window

TWHW8RANRA63.5W

● White
 UPC: 871193006731
 MC-40 / V-10



TWHW8RANRA63.5B

● Bronze
 UPC: 871193006724
 MC-40 / V-10



Window Operator - Miami Style Window

TWH13UNS92

● White

92mm

UPC: 871193005055

MC-40 / V-10



TWH13UNS78.8WH

● White

78.8mm

UPC: 871193000968

MC-40 / V-10



Window Operator - Miami Style Window

TWH13UAT78.8

● White

78.8mm

UPC: 871193005062

MC-40 / V-10



Window Operator - Miami Style Window

TWH13UNS1

● White

UNIVERSAL

UPC: 871193005024

MC-40 / V-10



TWH13UNS1B

● Bronze

UNIVERSAL

UPC: 871193006717

MC-40 / V-10

Window Operator - Miami Style Window

TWH13UAT1

● White

UNIVERSAL

UPC: 871193005031

MC-40 / V-10



TWH13UAT1B

● Bronze

UNIVERSAL

UPC: 871193006700

MC-40 / V-10



Window Operator - Security Window

TWH80WH

● White
 UPC: 871193009060
 MC-40 / V-10

TWH80UWH

● White
UNIVERSAL*
 UPC: 871193009060
 MC-40 / V-10



Window Operator - Miami Style Window

TWHW309W

● White
UNIVERSAL
 UPC: 871193005789
 MC-40 / V-10



Window Operator - Security Window

TWH200SEC

● White
 Right-Hand Function
 UPC: 871193005772
 MC-40 / V-10

TWH200SEC-LEFT

● White
 Left-Hand Function
 UPC: 871193007233
 MC-40 / V-10

TWH300SEC*

● White
 Right-Hand Function
 UPC: 810055042586
 MC-40 / V-10



Window Operator - Miami Style Window

TWH104L78.8W

● White
 UPC: 810055041138
 MC-40 / V-10



Operador de Ventanas - Ventana Estilo Miami

TW1178.8+CHAIN

- White
- 8' Chain
- UPC: 871193005307
- MC-40 / V-10

TW1178.8U+CHAIN

- White
- Cadena 8' Pies
- UNIVERSAL*
- UPC: 810055041312
- MC-40 / V-10



Operador de Ventanas - Ventana Estilo Miami

TW1078.8HD+CHAIN

- White
- 6' Heavy Duty Chain
- BULK - Packed in Bags
- UPC: 810055041305
- MC-40 / V-5



Window Operator - Security Window - BULK

White

TWHB200SEC

- Right-Hand Function
- BULK - Packed in Bags
- UPC: 810055043880
- MC-40 / V-10

Silver

TWHB200SECS

- Right-Hand Function
- BULK - Packed in Bags
- UPC: 810055043927
- MC-40 / V-10

Nogal

TWHB200SECN

- Right-Hand Function
- BULK - Packed in Bags
- UPC: 810055043941
- MC-40 / V-10

Matte Black

TWHB200SECMB

- Right-Hand Function
- BULK - Packed in Bags
- UPC: 810055043903
- MC-40 / V-10

TWHB200SEC-LEFT

- Left-Hand Function
- BULK - Packed in Bags
- UPC: 810055043897
- MC-40 / V-10

TWHB200SECS-LEFT

- Left-Hand Function
- BULK - Packed in Bags
- UPC: 810055043934
- MC-40 / V-10

TWHB200SECN-LEFT

- Left-Hand Function
- BULK - Packed in Bags
- UPC: 810055043958
- MC-40 / V-10

TWHB200SECMB-LEFT

- Left-Hand Function
- BULK - Packed in Bags
- UPC: 810055043910
- MC-40 / V-10



WINDOW OPERATORS



HARDWARE

Replacement Screw Set

TWH-KIT

UPC: 871193005796
MC-300 / V-15



Metal Screen Door Hinges

TWH21AL

Aluminum
UPC: 871193005017
MC-200 / V-10



TWH21WH

White
UPC: 871193005000
MC-200 / V-10



Window Screen Clips

TWC01W

6 Clips
White
UPC: 871193007011
MC-300 / V-15

TWC01S

6 Clips
Silver
UPC: 871193007004
MC-300 / V-15

TWC02W

6 Clipss
White
UPC: 871193007035
MC-300 / V-15

TWC02S

6 Clips
Silver
UPC: 871193007028
MC-300 / V-15

TWC03C

6 Clips
Clear
UPC: 871193007042
MC-300 / V-15

TWC02C

6 Clips
Clear
UPC: 871193003839
MC-300 / V-15

TWC04W

12 Clips
White
UPC: 871193002481
MC-200 / V-10

TWC04S

12 Clips
Silver
UPC: 871193002580
MC-200 / V-10

TWC05W

12 Clips
White
UPC: 871193002443
MC-200 / V-10

TWC05S

12 Clips
Silver
UPC: 871193002405
MC-200 / V-10

TWC04C

12 Clips
Clear
UPC: 871193002504
MC-200 / V-10

TWC05C

12 Clips
Clear
UPC: 871193002467
MC-200 / V-10



Pneumatic Door Closer

HEAVY DUTY

TC521S

Silver

UPC: 871193001668

MC-20 / V-5

TC521W

White

UPC: 871193001675

MC-20 / V-5

TC521B

Bronze

UPC: 871193006861

MC-20 / V-5



TC222S

Silver

UPC: 871193001644

MC-20 / V-5

TC222W

White

UPC: 871193001651

MC-20 / V-5



Metal Screen Door Lock

TP070SIN

Silver

UPC: 871193006939

MC-60 / V-5

TP070WOUT

White

UPC: 871193006922

MC-60 / V-5

TP070SOUT

Silver

UPC: 871193006915

MC-60 / V-5

TP070WIN

White

UPC: 871193006946

MC-60 / V-5

TP070B

Brown

UPC: 871193006878

MC-1 / V-5



Bottom Door Seal

ALUMINUM

TAR231 S

Silver / 1.5" x 36"

UPC: 871193005956

MC-50 / V-10

TAR231 W

White / 1.5" x 36"

UPC: 871193005949

MC-50 / V-10

TAR231 B

Bronze / 1.5" x 36"

UPC: 871193005932

MC-50 / V-10

PLASTIC

TPR231S

Silver / 1.5" x 36"

UPC: 871193009770

MC-50 / V-10

TPR231W

White / 1.5" x 36"

UPC: 871193009787

MC-50 / V-10

TPR231B

Bronze / 1.5" x 36"

UPC: 871193009763

MC-50 / V-10

VINYL

TSSS3C

Clear

1.5" x 36"

UPC: 871193009749

MC-50 / V-10

TSSS3W

White / 1.5" x 36"

UPC: 871193009732

MC-50 / V-10



Security Deadbolt / Patio Door

TDP02S

Grey
 UPC: 871193005345
 MC-36 / V-6

TDP02W

White
 UPC: 871193005338
 MC-36 / V-6

For sliding or hinged doors.



Sliding Window Lock

TSS02S

Grey
 UPC: 871193005383
 MC-36 / V-6

TSS02W

White
 UPC: 871193005376
 MC-36 / V-6



Sliding Door Latch

TWL979CP

Chrome
 UPC: 871193003853
 MC-80 / V-5

TWL979W

White
 UPC: 871193007240
 MC-80 / V-5



Window Lock

TWS02S

Grey
 UPC: 871193005369
 MC-36 / V-6

TWS02W

White
 UPC: 871193005352
 MC-36 / V-6



Includes multiple bolts for sliding windows.

Sliding Door Pull

TDP9763

Wood Handle
 UPC: 871193003860
 MC-72 / V-6



Friction Hinge for Aluminum Window

TWH122217BULK

12" x 22" x 17"

UPC: 871193007707

MC-25 / V-1

TWH162217BULK

16" x 22" x 17"

UPC: 871193007714

MC-25 / V-1

TWH242217BULK

24" x 22" x 17"

UPC: 871193007721

MC-50 / V-1



Bisagra de Fricción para Ventanas de Aluminio

TWHSSC10BULK

Aluminum

UPC: 871193007738

MC-100 / V-1



Window Holder

TWS006SSS

Stainless Steel

UPC: 871193002658

MC-48 / V-6

TWS006BF

Stainless Steel

Matte Black

UPC: 810055043712

MC-48 / V-12

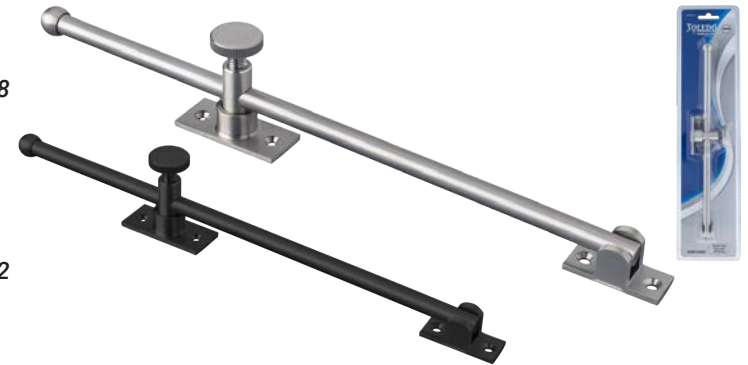

Security Pin

TSP801SS

Stainless Steel

UPC: 871193007479

MC-1 / V-8



Handles for Casement Windows

TBSC15WH

White

UPC: 871193009695

MC-120 / V-15

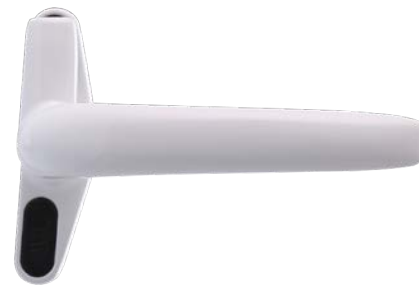
**TWHPWLBULK**

Antique Bronze

UPC: 871193007905

MC-150 / V-1



Single Roller

TWH64312

Blister Pack

UPC: 871193002542

MC-200 / V-10

**TWH64312BULK**

BULK

UPC: 871193007745

MC-200 / V-20

TWHA25

Blister Pack

UPC: 871193007691

MC-200 / V-10

**TWHRONY**

Blister Pack

UPC: 871193007899

MC-200 / V-10

**TWHRONYBULK**

BULK

UPC: 871193007882

MC-200 / V-20

Siliconized Weatherstripping for Doors and Windows

WS4.8X8.5X8.5/4P2

FACTORY: FN48X850

METERS: 350

FEET: 1148

UPC: 871193007943

MC-4 / V-1

WSFN4.8X6X6-4P2L

FACTORY: FN48X600

METERS: 500

FEET: 1640

UPC: 810055041022

MC-4 / V-1

WSFN6.8X6X6-4P2L

FACTORY: FN68X600

METERS: 400

FEET: 1312

UPC: 810055041039

MC-4 / V-1

WSSP4.8X6

FACTORY: SP48X600

METERS: 500

FEET: 1640

UPC: 810055041015

MC-4 / V-1

WS7X8.5/3P3L

FACTORY: SP68X850

METERS: 250

FEET: 820

UPC: 871193004751

MC-4 / V-1

WS5X8/3P2L

FACTORY: SP48X800

METERS: 400

FEET: 1312

UPC: 871193007912

MC-4 / V-1

WS6.7X6/3P3L

FACTORY: SP68X600

METERS: 400

FEET: 1312

UPC: 871193007929

MC-4 / V-1



FN= With Plastic

48= Fine Pile

Pile Length:

SP= Without Plastic

68= Thick Pile

850, 600, 800



Rollers for Sliding Doors and Windows

TWHA22SSBULK

Stainless Steel

BULK

UPC: 871193007677

MC-40 / V-5

**TWHA22BULK**

Laminated Zinc

BULK

UPC: 871193007660

MC-40 / V-10



HARDWARE

Toledo offers a wide range of high-quality products, including hinges, door closers, pulls, security latches, tension hardware, gate hardware, mailboxes, and more. Designed to ensure durability and functionality, all our hardware comes with a lifetime warranty, guaranteeing reliable performance for any residential or commercial need.



Concealed Hinges

TCH601

140 x 30mm
Steel
Weight Limit: 60KG / 2pc
UPC: 810055043293
MC-24 / V-2

TCH602

120 x 25mm
Steel
Weight Limit: 35KG / 2pc
UPC: 810055043293
MC-24 / V-2

TCH603

165 x 30mm
Steel
Weight Limit: 80KG / 2pc
UPC: 810055043316
MC-24 / V-2

TCH601B

140 x 30mm
Steel / MATTE BLACK
Weight Limit: 60KG / 2pc
UPC: 810055043613
MC-24 / V-2

TCH602B

120 x 25mm
Steel / MATTE BLACK
Weight Limit: 35KG / 2pc
UPC: 810055043767
MC-24 / V-2

TCH603B

165 x 30mm
Steel / MATTE BLACK
Weight Limit: 80KG / 2pc
UPC: 810055043620
MC-24 / V-2



Stainless Steel Hinges

A. Blister Pack (2 pz)

300250SS

3" x 3" x 2.5mm
UPC: 871193002788
MC-24 / V-6

350250SS

3.5" x 3.5" x 2.5mm
UPC: 871193002795
MC-24 / V-6

400250SS

4" x 4" x 2.5mm
UPC: 871193002801
MC-24 / V-6

435250SS

4" x 3.5" x 2.5mm
UPC: 871193007615
MC-24 / V-6

B. Box Packed(2 pz)

BP400300SS

4" x 4" x 3.0mm
UPC: 810055040483
MC-30 / V-1

450350SS

4.5" x 4.5" x 3.5mm
UPC: 871193005703
MC-30 / V-1

C. Blister Pack (3 pz)

300250SS(3PK)

3" x 3" x 2.5mm
UPC: 871193007523
MC-24 / V-6

350250SS(3PK)

3.5" x 3.5" x 2.5mm
UPC: 871193007516
MC-24 / V-6

400250SS(3PK)

4" x 4" x 2.5mm
UPC: 871193007509
MC-24 / V-6

FEATURES:

- Stainless Steel Alloy 304.
- Double Ball Bearing.
- Solid brass bar with "Non-Removable Pin" (NRP) for added security.



Stainless Steel Hinges

Blister Pack (2 pz)
400250AC
 ANTIQUE COPPER
 4" x 4" x 2.5mm
 UPC: 871193005505
 MC-24 / V-6



FEATURES:

- Stainless Steel Alloy 304.
- Double Ball Bearing.
- Solid brass bar with "Non-Removable Pin" (NRP).

Blister Pack (2 pz)
400250AB
 ANTIQUE BRONZE
 4" x 4" x 2.5mm
 UPC: 871193002849
 MC-24 / V-6



FEATURES:

- Stainless Steel Alloy 304.
- Double Ball Bearing.
- Solid brass bar with "Non-Removable Pin" (NRP).

Blister Pack (2 pz)
350250MB
 MATTE BLACK
 4" x 4" x 2.5mm
 UPC: 871193009794
 MC-24 / V-6



400250MB
 MATTE BLACK
 4" x 4" x 2.5mm
 UPC: 810055044290
 MC-24 / V-6

FEATURES:

- Stainless Steel Alloy 304.
- Double Ball Bearing.
- Solid brass bar with "Non-Removable Pin" (NRP).



HINGES



HARDWARE

Ball Bearing Hinges

Box Packed(2 pz)

350250SS304WS

STAINLESS STEEL
3.5"x 3.5"x 2.5mm

UPC: 810055044085

MC-50 / V-1



Box Packed(2 pz)

350250SS201WS

STAINLESS STEEL
3.5"x 3.5"x 2.5mm

UPC: 810055044047

MC-50 / V-1



Box Packed(2 pz)

350250SS201WS-B

MATTE BLACK
4"x 4"x 2.5mm

UPC: 810055044061

MC-50 / V-1



400250SS304WS

STAINLESS STEEL
4"x 4"x 2.5mm

UPC: 810055044092

MC-50 / V-1

400250SS201WS

STAINLESS STEEL
4"x 4"x 2.5mm

UPC: 810055044054

MC-50 / V-1

400250SS201WS-B

MATTE BLACK
4"x 4"x 2.5mm

UPC: 810055044078

MC-50 / V-1

400300SS304WS

STAINLESS STEEL
4"x 4"x 3mm

UPC: 810055044108

MC-50 / V-1

FEATURES:

- Stainless Steel Alloy 201.
- 2 hinges with ball bearings.
- Solid brass bar with "Non-Removable Pin" (NRP).
- Screws not included.

FEATURES:

- Stainless Steel Alloy 201.
- 2 hinges with ball bearings.
- Solid brass bar with "Non-Removable Pin" (NRP).
- Screws not included.

FEATURES:

- Stainless Steel Alloy 304.
- 2 hinges with ball bearings.
- Solid brass bar with "Non-Removable Pin" (NRP).
- Screws not included.



Steel Hinges

Blister Pack (2 pz)

300220ZP

ZINC PLATED
3" x 3" x 2.2mm

UPC: 871193002757

MC-24 / V-6



350220ZP

ZINC PLATED
3.5" x 3.5" x 2.2mm

UPC: 871193002764

MC-24 / V-6

400220ZP

ZINC PLATED
4" x 4" x 2.2mm

UPC: 871193002771

MC-24 / V-6

Blister Pack (2 pz)

300220BP

POLISHED BRASS
3" x 3" x 2.2mm

UPC: 871193002726

MC-24 / V-6



350220BP

POLISHED BRASS
3.5" x 3.5" x 2.2mm

UPC: 871193002733

MC-24 / V-6

400220BP

POLISHED BRASS
3.5" x 3.5" x 2.2mm

UPC: 8302109030

MC-24 / V-6

Flush Hinges in Stainless Steel

Blister Pack (2 pz)

FH300200SS

3" x 1.26" x 2mm

UPC: 810055041787

MC-1 / V-6



FH350200SS

3.5" x 1.38" x 2mm

UPC: 810055041770

MC-1 / V-6

FH400250SS

4" x 2" x 2.5mm

UPC: 810055041763

MC-1 / V-6

FEATURES:

- Stainless Steel Alloy 304.
- 2 hinges with ball bearings.
- No need to mark the door and frame for installation.



HINGES



HARDWARE

Double Action Hinges

Blister Pack (2 pz)

DA300150SS

STAINLESS STEEL

3.0" x 1.5mm

UPC: 871193006335

MC-24 / V-3



DA400150SS

STAINLESS STEEL

4.0" x 1.5mm

UPC: 871193006342

MC-1 / V-3

DA600150SS

STAINLESS STEEL

5.0" x 1.5mm

UPC: 871193006359

MC-1 / V-3



Hinge Marker

Blister Pack (1 pz)

BM300

3"

UPC: 871193008315

MC-48 / V-6



BM312

3 1/2"

UPC: 871193008322

MC-48 / V-6

BM400

4"

UPC: 871193008339

MC-48 / V-6



Micro Automatic Door Closer

TMDC01

UPC: 871193009534

MC-1 / V-5



Automatic Closing Hinge Pin

AHDC01

UPC: 99038803

MC-48 / V-6



Hinges

LIGHTWEIGHT / ZINC PLATED
Blister Card (2 pz)

TLH25ZP

1"
UPC: 871193004157
MC-120 / V-10

TLH38ZP

1.5"
UPC: 871193004164
MC-120 / V-10

TLH50ZP

2"
UPC: 871193004171
MC-120 / V-10

TLH65ZP

2.5"
UPC: 871193004188
MC-120 / V-10

TLH75ZP

3"
UPC: 871193004195
MC-120 / V-10



T-Shaped Hinges

LIGHTWEIGHT / ZINC PLATED
A. Blister Card (2 pz)

TLT50ZP

2"
UPC: 871193004058
MC-120 / V-10

TLT75ZP

3"
UPC: 871193004065
MC-120 / V-10

TLT10ZP

4"
UPC: 871193004072
MC-120 / V-10

TLT15ZP

6"
UPC: 871193008520
MC-120 / V-10

HEAVY DUTY / ZINC PLATED
B. Blister Packr (2 pz)

THT10ZP

4"
UPC: 871193004089
MC-60 / V-5

THT12ZP

5"
UPC: 871193004096
MC-60 / V-5

THT15ZP

6"
UPC: 871193004102
MC-30 / V-5

THT20ZP

8"
UPC: 871193004119
MC-120 / V-5



Heavy Duty T-Shaped Hinges

Blister Pack (1 pz)

THT10SS

STAINLESS STEEL
4"
UPC: 871193006526
MC-48 / V-6

THT12SS

STAINLESS STEEL
5"
UPC: 871193006533
MC-48 / V-6

THT15SS

STAINLESS STEEL
6"
UPC: 871193006540
MC-48 / V-6

THT20SS

STAINLESS STEEL
8"
UPC: 871193006557
MC-48 / V-6



HINGES



HARDWARE

Strap Hinges

LIGHTWEIGHT / ZINC PLATED

A. Blister Pack (2 pz)

LSH50ZP

2"

UPC: 871193008483

MC-48 / V-12

LSH75ZP

3"

UPC: 871193008490

MC-48 / V-12

LSH10ZP

4"

UPC: 871193008506

MC-48 / V-12

LSH15ZP

6"

UPC: 871193008513

MC-24 / V-12

HEAVY DUTY / ZINC PLATED

B. Blister Pack (2 pz)

TSH10ZP

4" / 10.16 cm

UPC: 871193004126

MC-120 / V-6

TSH12ZP

5" / 12.70 cm

UPC: 871193004096

MC-30 / V-10



Continuous Hinges

Bag + Card Packaging(1 pz)

CH11212SS

12" / 300mm

UPC: 871193009619

MC-120 / V-5

CH11224SS

24" / 600mm

UPC: 871193009626

MC-60 / V-5

CH11236SS

36" / 900mm

UPC: 871193009626

MC-50 / V-5

CH11248SS

48" / 1200mm

UPC: 871193009640

MC-50 / V-5

CH11272SS

72" / 1800mm

UPC: 871193009657

MC-40 / V-5



Mending Plates

ZINC PLATED

Blister Pack (4 pz)

TMP105

2" x 5/8"

UPC: 871193004027

MC-120 / V-10

TMP112

5" x 1"

UPC: 871193008827

MC-120 / V-10

TMP107

3"

UPC: 871193004034

MC-120 / V-10

TMP110

48" / 1200mm

UPC: 871193004041

MC-120 / V-10



Bar Holder

TBH01

Blister Pack (2 pz)

UPC: 871193009206

MC-36 / V-6



HINGES



HARDWARE

Corner Braces

ZINC PLATED
A. Blister Card (4 pz)
TCB125
1"
UPC: 871193003884
MC-120 / V-10

TCB138
1 1/2"
UPC: 871193003891
MC-120 / V-10

TCB150
2"
UPC: 871193003907
MC-120 / V-10

TCB165
2 1/2"
UPC: 871193003914
MC-10 / V-10

TCB175
3"
UPC: 871193003921
MC-60 / V-10

TCB189
3 1/2"
UPC: 871193002368
MC-50 / V-10

TCB100
4"
UPC: 871193003938
MC-60 / V-10



STAINLESS STEEL
B. Blister Pack (2 pz)
TCB138SS
1.5"
UPC: 871193006434
MC-48 / V-6

TCB150SS
2.0"
UPC: 871193006441
MC-48 / V-6

TCB165SS
2.5"
UPC: 871193006458
MC-12 / V-6

TCB175SS
3.0"
UPC: 871193006465
MC-12 / V-6

TCB100SS
4.0"
UPC: 871193006472
MC-48 / V-6



Tee Plates

ZINC PLATED
Blister Card (4 pz)
TTP65
2.5"
UPC: 871193003990
MC-120 / V-10

TTP75
3"
UPC: 871193004003
MC-120 / V-10

TTP100
4"
UPC: 871193004010
MC-120 / V-10

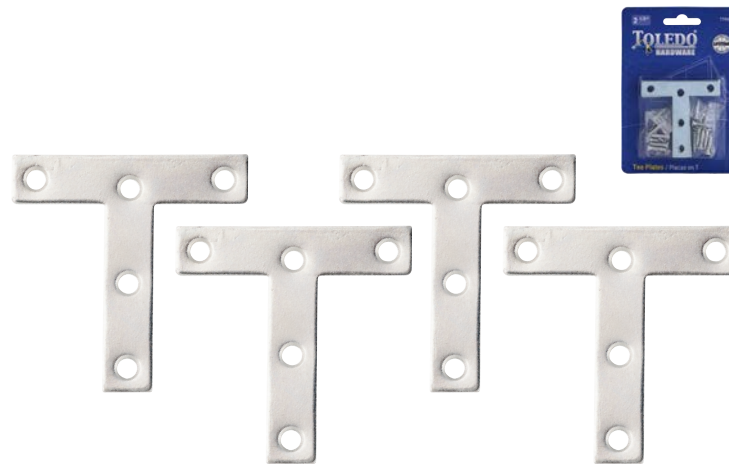

Flat Corners

ZINC PLATED
Blister Card (4 pz)

TFC138
1 1/2"
UPC: 871193003945
MC-120 / V-10

TFC150
2"
UPC: 871193003952
MC-120 / V-10

TFC165
2 1/2"
UPC: 871193003969
MC-120 / V-10

TFC175
3"
UPC: 871193003976
MC-60 / V-10

TFC100
4"
UPC: 871193003983
MC-60 / V-10



Cabinet Hinges

TCH01

Steel
35mm
UPC: 871193007387
MC-90 / V-10

**TCH02**

Steel
Soft Closing
35mm
UPC: 871193007394
MC-90 / V-10

**TCH02S**

Stainless Steel
Soft Closing
35mm
UPC: 871193007400
MC-90 / V-10

**TSAH04**

Steel
Soft Closing
Placa de Liberación
35mm
UPC: 810055041701
MC-90 / V-10

**TCH03**

Steel
35mm
UPC: 871193009251
MC-120 / V-10

**TCH04.**

Steel
Soft Closing
UPC: 871193009268
MC-120 / V-10

**TCH04S.**

Stainless Steel
Soft Closing
UPC: 871193009275
MC-120 / V-10



Cabinet Hinges

TSCH01AB

Antique Bronze
UPC: 871193009176
MC-120 / V-10

**TSCH01SN**

Satin Nickel
UPC: 871193009183
MC-120 / V-10

**TSCH01WH**

White
UPC: 871193009190
MC-120 / V-10

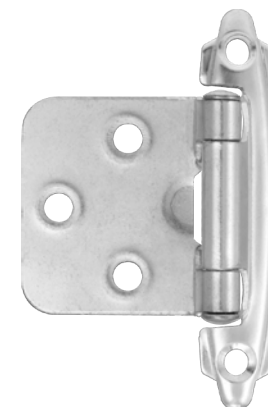
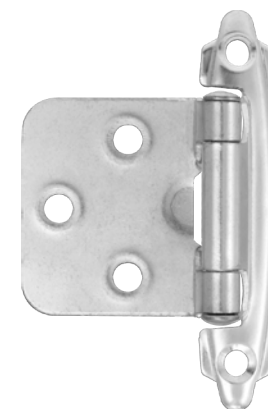

Double Roller Catcher

TRC01

UPC: 871193007332
MC-120 / V-10



Ball Catch

TBC003SSS

Stainless Steel

UPC: 871193002634

MC-1 / V-6



Adjustable Ball Catch

TBC21SN

Satin Nickel

UPC: 871193008391

MC-96 / V-6



Ball Catch

TBC21CP

Cromado

UPC: 871193004546

MC-96 / V-6



Double Ball Catch

40SBDC

Solid Brass

UPC: 871193006175

MC-96 / V-8

50SBDC

Solid Brass

UPC: 871193003013

MC-96 / V-8

60SBDC

Solid Brass

UPC: 871193003075

MC-96 / V-8

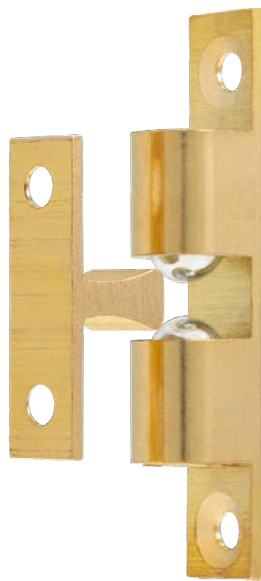

Magnetic Door Catcher

MDC01

UPC: 871193006182

MC-60 / V-10



Magnetic Cabinet Latch

MCTL1516

1 5/16" x 1 1/8"

UPC: 871193008476

MC-96 / V-6



Double Magnetic Cabinet Catch

DMCC01

Aluminum

UPC: 871193008469

MC-96 / V-6



Adjustable Magnetic Cabinet Catch

AMCC2114

Aluminum

UPC: 871193008452

MC-96 / V-6



Heavy Duty Door Closers

TC101
 UPC: 871193001132
 MC-10 / V-1

TC102
 UPC: 871193001149
 MC-10 / V-1

TC103
 UPC: 871193001156
 MC-10 / V-1

TC104
 UPC: 871193001163
 MC-10 / V-1

TC101W
 UPC: 871193002146
 MC-10 / V-1

TC102W
 UPC: 871193002153
 MC-1 / V-1

TC103W
 UPC: 871193002160
 MC-1 / V-1

TC104W
 UPC: 871193002931
 MC-1 / V-1

TC101B
 UPC: 871193002962
 MC-1 / V-1

TC102B
 UPC: 871193002979
 MC-10 / V-1

TC103B
 UPC: 871193002986
 MC-1 / V-1

TC104B
 UPC: 871193002993
 MC-10 / V-1



Silver



White



Bronze

- Double Valve System with Standard Arm.
- Maximum Opening Angle: 180°

CERTIFICATION: UL-rated door closer for 3-hour fire resistance, UL 10C.

Dimensions and Maximum Load Capacity Guide

TC101
 31" x 80" (78.74 cm x 203.20 cm)
 33 a 66 lbs. (14.97 kg a 29.94 kg)

TC102
 35" x 83" (88.90 cm x 210.82 cm)
 55 a 99 lbs. (24.95 kg a 44.91 kg)

TC103
 37" x 83" (93.98 cm x 210.82 cm)
 88 a 143 lbs. (39.92 kg a 64.86 kg)

TC104
 41" x 106" (104.14 cm x 269.24 cm)
 132 a 187 lbs. (59.87 kg a 84.82 kg)



Sign Plates

TSP001SSS
 Men
 Stainless Steel
 10cm x 10cm x .15cm
 UPC: 871193001330
 MC-72 / V-6



TSP002SSS
 Women
 Stainless Steel
 10cm x 10cm x .15cm
 UPC: 871193001347
 MC-40 / V-6



Single Door Magnetic Lock

TM300S
 UPC: 871193005420
 MC-12 / V-1

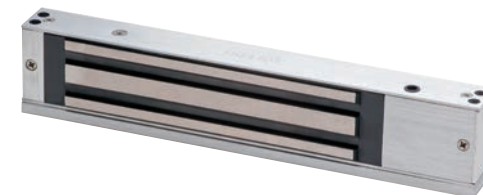

Panic Device Handle

TL900US26D

UPC: 810055042364

MC-20 / V-1



BHMA
CERTIFIED®



Panic Device

TPANICD01

Maximum Door Width: 49.21" (1250mm)

Maximum Door Weight: 264.55 lbs (120 kg)

UPC: 871193007202

MC-6 / V-1



Sign Plates Push & Pull

TPH

PUSH

Stainless Steel

UPC: 871193006670

MC-48 / V-1

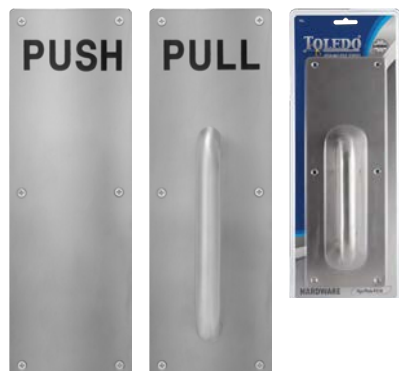

TPL

PULL

Stainless Steel

UPC: 871193006687

MC-18 / V-1

Placa de Protección para Puertas

DKP834

8" x 34"

Aluminum / Satin Nickel

UPC: 871193008438

MC-10 / V-1

DKP836

8" x 36"

Aluminum / Satin Nickel

UPC: 871193008445

MC-10 / V-1

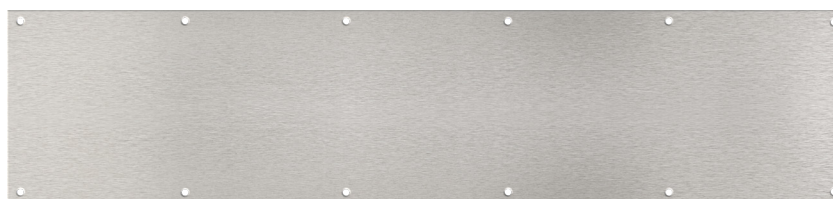

Floor Grab Bar

TGB2530L

Stainless Steel

Left-Hand Function

UPC: 810055041091

MC-4 / V-1

TGB2530R

Stainless Steel

Right-Hand Function

UPC: 810055041107

MC-4 / V-1



Grab Bar

STAINLESS STEEL

TGB101 12"

UPC: 871193009541

MC-12 / V-2

TGB101 18"

UPC: 871193009558

MC-12 / V-2

TGB201 24"

UPC: 871193009565

MC-12 / V-2

TGB251 30"

UPC: 871193009572

MC-12 / V-2

TGB301 36"

UPC: 871193009589

MC-12 / V-2

TGB351 42"

UPC: 871193009596

MC-12 / V-2

TGB401 48"

UPC: 871193009602

MC-12 / V-2



HARDWARE



HARDWARE

Concealed Handles

TFH006SSS

304 Stainless Steel
Satin
10.2 x 5.1 cm
UPC: 871193001231
MC-72 / V-6



TFH006BF

304 Stainless Steel
Matte Black
UPC: 810055044160
MC-72 / V-6

TRCM007

304 Stainless Steel
4.75 x 1.31 cm
UPC: 871193004720
MC-96 / V-8



TRCM008

304 Stainless Steel
Front Holes
4.75 x 1.31 cm
UPC: 810055044139
MC-96 / V-8



TRCM008BF

304 Stainless Steel
Matte Black
Front Holes
4.75 x 1.31 cm
UPC: 810055044146
MC-96 / V-8

TRCM001

304 Stainless Steel
12.90 cm
UPC: 871193004737
MC-1 / V-9



Type A Door Pulls

Matte Black

TDP107B

3"
UPC: 871193009947
MC-120 / V-10



TDP110B

4"
UPC: 871193009954
MC-120 / V-10

TDP112B

5"
UPC: 871193009961
MC-120 / V-10

TDP115B

6"
UPC: 871193009978
MC-120 / V-10

Stainless Steel

TDP110SS

4"
UPC: 871193006496
MC-48 / V-6

TDP112SS

5.5"
UPC: 871193006502
MC-120 / V-6

TDP115SS

6.5"
UPC: 871193006519
MC-48 / V-6



White

TDP107W

3"
UPC: 871193007349
MC-120 / V-10

TDP110W

4"
UPC: 871193007356
MC-120 / V-10

TDP112W

5"
UPC: 871193007363
MC-120 / V-10

TDP115W

6"
UPC: 871193007370
MC-120 / V-10



Chrome

TDP107CP

3"
UPC: 871193003761
MC-120 / V-10

TDP110CP

4"
UPC: 871193003778
MC-120 / V-10

TDP112CP

5"
UPC: 871193003785
MC-120 / V-10

TDP115CP

6"
UPC: 871193003792
MC-120 / V-10



Top Security Handles

TH19US26

Chrome
 UPC: 871193001323
 MC-36 / V-6

TH19US11

Antique Copper
 UPC: 871193009213
 MC-36 / V-6

TH19US15

satin Nickel
 UPC: 871193001309
 MC-36 / V-6

TH19US514

Matte Black
 UPC: 810055040025
 MC-36 / V-6

TH19US5

Antique Bronze
 UPC: 871193001316
 MC-36 / V-6



Cabinet Handles

TH1150

5.1" / 150 mm
 BULK
 UPC: 810055041794
 MC-400 / V-10



TH1200

7.8" / 200 mm
 BULK
 UPC: 810055041800
 MC-400 / V-10

TH1250

9.8" / 250 mm
 BULK
 UPC: 810055041817
 MC-400 / V-10

Door Handle

TDH023

Matte Black
 UPC: 810055043286
 MC-72 / V-6



HARDWARE



HARDWARE

Barrel Bolt

Zinc Plated

TFB150ZP

2" / 5.8cm

UPC: 871193003518

MC-120 / V-10

TFB165ZP

2.5" / 6.35 cm

UPC: 871193003525

MC-120 / V-10

Black Matte

TFB150B

2" / 5.8cm

UPC: 871193007417

MC-120 / V-10

TFB175B

3" / 7.62cm

UPC: 871193007424

MC-120 / V-10

Polished Bronze

THB50BP

2" / 5.8cm

UPC: 871193003570

MC-120 / V-10

THB65BP

2.5" / 6.35 cm

UPC: 871193003587

MC-120 / V-10

Zinc Plated / Heavy Duty

HDBB112ZP

5"

UPC: 871193008414

MC-30 / V-5

HDBB120ZP

8"

UPC: 871193008421

MC-24 / V-6

TFB175ZP

3" / 7.62cm

UPC: 871193003532

MC-120 / V-10

TFB110ZP

4" / 6.35 cm

UPC: 871193003549

MC-120 / V-10

TFB110B

4" / 6.35 cm

UPC: 871193007431

MC-120 / V-10

TFB112B

5" / 12.70cm

UPC: 871193007448

MC-120 / V-10

THB75BP

3" / 7.62cm

UPC: 871193003594

MC-120 / V-10

THB125BP

5" / 12.70cm

UPC: 871193003617

MC-120 / V-10

TFB112ZP

5" / 12.70cm

UPC: 871193003556

MC-120 / V-10

TFB115ZP

6" / 15.24cm

UPC: 871193003563

MC-120 / V-10

TFB115B

6" / 15.24cm

UPC: 871193007455

MC-120 / V-10

THB150BP

6" / 15.24cm

UPC: 871193003624

MC-120 / V-10



Padlock Eye



STAINLESS STEEL

TDB4SSS

4" / 10.0 cm

Stainless Steel Screws

UPC: 871193001408

MC-60 / V-5

TDB8SSS

8" / 20.0 cm

Stainless Steel Screws

UPC: 871193004782

MC-60 / V-5

TDB12SSS

12" / 30.0 cm

Stainless Steel Screws

UPC: 871193003358

MC-36 / V-6



Hasp Lock

THS907CP

3" / 7.62cm

UPC: 871193003709

MC-120 / V-10

THS911CP

4.5" / 11.43cm

UPC: 871193003716

MC-120 / V-10



Safety Hasp

Zinc Plated

THS506ZP

2.5" / 6.33 cm
UPC: 871193003662
MC-120 / V-10

THS511ZP

4.5" / 11.43 cm
UPC: 871193003686
MC-120 / V-10

THS508ZP

3.5" / 8.89 cm
UPC: 871193003679
MC-120 / V-10

THS515ZP

6" / 15.24 cm
UPC: 871193003693
MC-120 / V-10



Zinc Plated

THS408ZP

3.5" / 8.89 cm
UPC: 871193003631
MC-120 / V-10

THS415ZP

6" / 15.24 cm
UPC: 871193003655
MC-120 / V-10

THS411ZP

4.5" / 11.43 cm
UPC: 871193003648
MC-120 / V-10



Camlock

TT3516

0.63" / 16mm
UPC: 871193001071
MC-144 / V-6

TT3525

0.98" / 25mm
UPC: 871193001095
MC-144 / V-6

TT3520

0.79" / 20mm
UPC: 871193001088
MC-144 / V-6

TT3530

1.18" / 30mm
UPC: 871193001101
MC-144 / V-6



Drawer Lock

TDL01

UPC: 871193009244
MC-120 / V-10



TDL02SN

UPC: 871193006120
MC-48 / V-6



Sliding Door Lock

TSLH14CP

UPC: 871193004263
MC-120 / V-10



HARDWARE



HARDWARE

Door Reinforcer

TDR03

Aluminum

UPC: 810055043248

MC-72 / V-6



Door Bolt

TDB02BR

Brass

2"

UPC: 871193002696

MC-72 / V-6

TDB04BR

Brass

4"

UPC: 871193001569

MC-72 / V-6

TDB06BR

Brass

6"

UPC: 871193001583

MC-72 / V-6



Door Bolt

TB002 2.5"

Satin Nickel

UPC: 871193001965

MC-168 / V-7

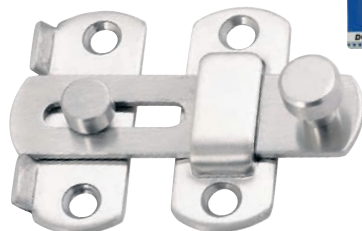

Stainless Steel Security Bolt

TSB001

3"

Stainless Steel

UPC: 810055043262

MC-72 / V-6

TSB002

4"

Stainless Steel

UPC: 810055043279

MC-72 / V-6



Safety Latch

TSL01

UPC: 871193007325

MC-120 / V-10



Door Guard

TDG002SSS

10.7 cm x 6.3 cm

Stainless Steel

UPC: 871193001385

MC-64 / V-5

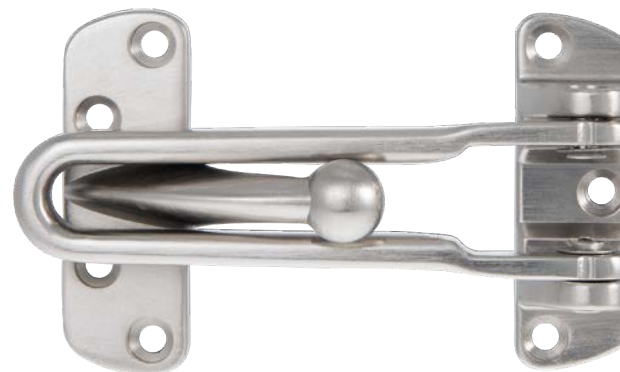

Dust Proof Strike

TDPS003SSS

50cm x 2.5cm
Stainless Steel
UPC: 871193004942
MC-72 / V-6



TDPS003MB

50cm x 2.5cm
Stainless Steel
Matte Black
UPC: 810055044238
MC-40 / V-10



Flush Bolts

TFB006 12"
UPC: 871193004928
MC-24 / V-8



TFB005 12"
Stainless Steel
UPC: 871193007936
MC-24 / V-8



TFB007SS 12"
STAINLESS STEEL
UPC: 810055042418
MC-24 / V-8



TFB007BF 12"
Stainless Steel
Matte Black
UPC: 810055043705
MC-24 / V-8



Safety Gate Lock

SGH200

2"
Steel
UPC: 871193008209
MC-120 / V-10

SGH300

3"
Steel
UPC: 871193008216
MC-120 / V-10



GH200

2"
Steel
UPC: 871193008162
MC-192 / V-12

GH300

3"
Steel
UPC: 871193008179
MC-96 / V-12

GH400

4"
Steel
UPC: 871193008186
MC-96 / V-12

GH600

6"
Steel
UPC: 871193008193
MC-48 / V-12



Door Holder

TDH023SCP

Satin Chrome Plated
 UPC: 871193002528
 MC-48 / V-12



TDH023B

Satin Black
 UPC: 810055041053
 MC-48 / V-12

TDH1314WH

White
 UPC: 871193006328
 MC-48 / V-12

TDH1314CP

Chrome Plated
 UPC: 871193003426
 MC-120 / V-10

TDH1314B

Matte Black
 UPC: 871193009985
 MC-48 / V-12



Door Holder

TDH084SN

Satin Nickel
 UPC: 871193001538
 MC-40 / V-5



Floor Door Stop and Holder

TDS081SSS

2.8 cm x 4.5cm
 Satin Stainless Steel
 UPC: 871193001248
 MC-48 / V-6



TDS081B

2.8 cm x 4.5cm
 Matte Black
 UPC: 810055040001
 MC-48 / V-6



Wall Door Stop and Holder

TDS1319SC

Satin Nickel
 UPC: 871193003419
 MC-72 / V-6



Floor Door Stop and Holder

TDS1320SC

Satin Nickel
 UPC: 810055043255
 MC-48 / V-6



Magnetic Wall Door Holder

TMH14

Satin Nickel
 UPC: 871193004980
 MC-60 / V-5



TMH14B

Black Mate
 UPC: 810055041046
 MC-60 / V-5



Magnetic Floor Door Holder

TMH05

Satin Nickel
 UPC: 871193004942
 MC-72 / V-6



Magnetic Floor Door Holder

TDC025

Satin Nickel

UPC: 810055043255

MC-72 / V-6



Magnetic Floor Door Stop

TDS13

Satin Chrome

UPC: 871193004973

MC-72 / V-6



Magnetic Floor Door Stop

TDS07

Satin Nickel

UPC: 871193004959

MC-72 / V-6



Floor Door Stop

TDS002SSS

1.75" x 1/8"

Satin Stainless Steel

UPC: 871193006015

MC-96 / V-8

**TDS002B**

1.75" x 1/8"

Matte Black

UPC: 871193009992

MC-96 / V-8

Wall Door Stop

TWS09

UPC: 871193004966

MC-84 / V-7



Wall Door Stop

TDS031SSS

9.5 cm x 4.5cm

Satin Stainless Steel

UPC: 871193002566

MC-40 / V-5

**TDS1360SC**

1.75" x 1/8"

Satin Chrome

UPC: 871193003402

MC-120 / V-10



Small Wall Door Stop

CWD100

1"

Satin Chrome

UPC: 871193008360

MC-192 / V-12



Door Stop and Hook

TDSH044SS

7.4 cm x 2.0cm

Satin Stainless Steel

UPC: 871193001620

MC-40 / V-5



Rubber Door Stop

TRDS4 4"

Rubber
UPC: 810055041589
MC-96 / V-12

TRDS5 5"

Rubber
UPC: 810055041596
MC-48 / V-12



Wall Door Holder

TDH001

5 cm x 5.5 cm
Steel
UPC: 871193006656
MC-72 / V-12



Adjustable Door Spring

TDC01

2 Hooks Included
UPC: 871193005390
MC-120 / V-10



Dome-Shaped Wall Protector

DSD214

2 1/4"
Plastic
UPC: 871193008353
MC-96 / V-12



Smooth Wall Protector

WPS314

3 1/4"
Plastic
UPC: 871193008407
MC-48 / V-12



Door Latch Protector

TLP001

6"
Stainless Steel
UPC: 871193005413
MC-24 / V-6



TLP002SS

3.5" x 11.75"
Stainless Steel
UPC: 871193006649
MC-36 / V-6

Interior Door Reinforcement

TDR-1

1 3/4"
Exterior Door
UPC: 871193004409
MC-24 / V-5

TDR-2

1 3/8"
Interior Door
UPC: 871193005697
MC-30 / V-5



Hole Filler Plate

TFP01SSS

Stainless Steel
UPC: 871193004409
MC-72 / V-6



Reinforcement Ring

TA002SS

3 3/8"
Stainless Steel
UPC: 871193001941
MC-72 / V-6



Brass Door Viewer

TDV160SN

UPC: 871193001934

MC-120 / V-10



Door Viewer with Cover

TB34SN

UPC: 871193003440

MC-96 / V-8

TB34B

UPC: 810055040018

MC-96 / V-8



Lock Installation Kit

TOHS01

Wooden Doors

UPC: 871193003006

MC-36 / V-3



- Precision guide for door hole alignment.
- 2 1/8" (5.40 cm) and 1" (2.54 cm) hole saws.
- Router bit adjustable to drill.
- Latch plate template and 3/8" (.95 cm) mandrel.

TOHS22

Wooden or Metal Doors

UPC: 871193002351

MC-36 / V-3



- Precision guide for door hole alignment.
- 2 1/8" (5.40 cm) and 1" (2.54 cm) cylinder hole saws.
- Adjustable router bit for drill compatibility.
- Latch plate template and 3/8" (.95 cm) mandrel.

HARDWARE



HARDWARE

Door Lock Key Blanks

TK7

Door Lock
Grade 3 Keys
UPC: 871193004768
MC-2,000 / V-100



Door Lock Key Blanks

TK8

Platinum Door Lock
Grade 2 Keys
UPC: 871193004829
MC1- / V-100



Door Lock Key Blanks

TK9

Commercial Door Lock
Grade 2 Keys
UPC: 871193003464
MC1- / V-100



Door Lock Key Blanks

Keyblanks

Mortise Cylinder Security Keys
UPC: 871193006823
MC-1,000 / V-1



Padlock Key Blanks

TBK6-RO

Black Series & Aluminum
Padlock Keys
UPC: 871193005574
MC-1,000 / V-100



Key Ring Locks

TKR50

2"
UPC: 871193007264
MC-120 / V-10

TKR75

3"
UPC: 871193007271
MC-120 / V-10

TKR85

3.5"
UPC: 871193007288
MC-120 / V-10



Padlock Key Blanks

10440-40

30mm - 40mm
UPC: 99999992956
MC-100 / V-100



Padlock Key Blanks

10440-50

50mm - 70mm
UPC: 999999002969
MC-100 / V-100



Tension
HARDWARE



Lag Screw

LEB3/16X3

3/16" X 3"

UPC: 810055041510

MC-288 / V-24

LEB3/16X6

3/16" x 6"

UPC: 810055041473

MC-288 / V-24

LEB1/4X3-3/4

1/4" X 3.75"

UPC: 810055041527

MC-288 / V-24

LEB1/4X5

1/4" X 5"

UPC: 810055041534

MC-288 / V-24

LEB1/4X6

1/4" X 6"

UPC: 810055041480

MC-24 / V-24

LEB5/16X4

5/16" X 4"

UPC: 810055041541

MC-192 / V-24

LEB5/16X5

5/16" X 5"

UPC: 810055041558

MC-192 / V-24

LEB5/16X6

5/16" X 6"

UPC: 810055041497

MC-24 / V-24

LEB3/8X4-1/2

3/8" X 4.5"

UPC: 810055041565

MC-288 / V-24

LEB3/8X6

3/8" X 6"

UPC: 810055041503

MC-192 / V-24

LEB3/8X8

3/8" X 8"

UPC: 810055041572

MC-96 / V-12



Screw Hook Eye

SHE3/16X4

3/16" X 4"

UPC: 810055041329

MC-1 / V-24

SHE1/4X4

1/4" X 5"

UPC: 810055041336

MC-288 / V-24

SHE1/4X5

1/4" X 5"

UPC: 810055041442

MC-24 / V-24

SHE5/16X4

5/16" X 4"

UPC: 810055041343

MC-192 / V-24

SHE5/16X5

5/16" X 5"

UPC: 810055041459

MC-192 / V-24

SHE3/8X4

3/8" X 4"

UPC: 810055041381

MC-24 / V-24

SHE3/8X5

3/8" X 5"

UPC: 810055041466

MC-192 / V-24



Eye Bolt with Nut

TEB3161

3/16" x 1-3/4"

UPC: 810055040032

MC-1 / V-24

TEB3162

3/16" x 2-1/2"

UPC: 810055040049

MC-1 / V-24

TEB3163

3/16" x 3"

UPC: 810055040056

MC-1 / V-24

TEB0142

1/4" x 2"

UPC: 810055040063

MC-500 / V-24

TEB1425

1/4" x 2-1/2"

UPC: 810055040070

MC-1 / V-24

TEB0143

1/4" x 3"

UPC: 810055040087

MC-500 / V-24

TEB0144

1/4" x 4"

UPC: 810055040094

MC-500 / V-24

TEB0145

1/4" x 5"

UPC: 810055040100

MC-350 / V-24

TEB5163

5/16" X 3-1/4"

UPC: 810055040117

MC-334 / V-24

TEB5164

5/16" X 4"

UPC: 810055040124

MC-1 / V-24

TEB5165

5/16" X 5"

UPC: 810055040131

MC-1 / V-24

TEB5166

5/16" X 6"

UPC: 810055040148

MC-1 / V-24

TEB0384

3/8" X 4"

UPC: 810055040155

MC-1 / V-24

TEB0385

3/8" X 5"

UPC: 810055040162

MC-100 / V-24

TEB0386

3/8" X 6"

UPC: 810055040179

MC-1 / V-24

TEB0388

3/8" X 8"

UPC: 810055040186

MC-1 / V-12

TEB0126

1/2" X 6"

UPC: 810055040193

MC-1 / V-12

TEB0128

1/2" X 8"

UPC: 810055040209

MC-50 / V-12

TEB1210

1/2" X 10"

UPC: 810055040216

MC-1 / V-12



Rope Binding Hook

RBH2116

2-1/16"

UPC: 871193008148

MC-192 / V-12

RBH0334

3-3/4"

UPC: 871193008155

MC-96 / V-12



Swivel

SW214012 2-1/4"

Eye Opening 1/2"

UPC: 871193008070

MC-120 / V-10

SW234034 2-3/4"

Eye Opening 3/4"

UPC: 871193008087

MC-120 / V-10

SW318100 3-1/8"

Eye Opening 1"

UPC: 871193008094

MC-120 / V-10



Aluminum Sleeve

ALS3/16

UPC: 810055041404

MC-120 / V-10

ALS3/8

UPC: 810055041435

MC-120 / V-10

ALS5/16

UPC: 810055041428

MC-120 / V-10

ALS1/4

UPC: 810055041411

MC-120 / V-10



S Hook

TSHK3/16

UPC: 871193003297

MC-120 / V-10

TSHK5/16

UPC: 871193006113

MC-120 / V-10

TSHK1/4

UPC: 871193002917

MC-120 / V-10



Quick Link Connector

TQL1/4

UPC: 871193009930

MC-120 / V-10

TQL3/8

UPC: 871193003747

MC-120 / V-10

TQL5/16

UPC: 871193003730

MC-120 / V-10

TQL3/16

UPC: 871193003488

MC-120 / V-10



Wire Rope Thimble

WRT316 3/16"

UPC: 871193008278

MC-1 / V-102

WRT516 5/16"

UPC: 871193008292

MC-96 / V-12

WRT014 1/4"

UPC: 871193008285

MC-96 / V-12

WRT038 3/8"

UPC: 871193008308

MC-96 / V-12



Snap Hook

SHG316200

3/16" x 2"

UPC: 871193008100

MC-120 / V-10

SHG516318

5/16" x 3-1/8"

UPC: 871193008124

MC-120 / V-10

SHG014238

1/4" x 2-3/8"

UPC: 871193008117

MC-120 / V-10

SHG038400

3/8" x 4"

UPC: 871193008131

MC-96 / V-12



Turnbuckle

TBCK3/16

UPC: 871193009930
MC-120 / V-10

TBCK5/16

UPC: 871193003730
MC-120 / V-10

TBCK1/4

UPC: 871193003747
MC-120 / V-10

TBCK3/8

UPC: 871193003488
MC-120 / V-10



Wire Rope Clip

TWR3/16

UPC: 871193004201
MC-120 / V-10

TWR5/16

UPC: 871193006236
MC-120 / V-10

TWR1/4

UPC: 871193004249
MC-120 / V-10

TWR3/8

UPC: 871193006229
MC-90 / V-10

TWR1/2

UPC: 871193006274
MC-60 / V-10



Wire Rope with PVC Coating

WC1/8TO3/16X50

50' ft
UPC: 871193009701
MC-1 / V-10

WC1/8TO3/16X200

200' ft
UPC: 871193003365
MC-1 / V-1

WC3/16TO1/4X200

200' ft
UPC: 871193004218
MC-1 / V-1

WC1/4TO5/16X200

200' ft
UPC: 871193004225
MC-1 / V-1

WC5/16TO3/8X200

200' ft
UPC: 871193004232
MC-1 / V-1



ITEM#	Minimum Breaking Load (KN)	Maximum Working Load (KN)	NET WEIGHT KG	GROSS WEIGHT KG	CBM	Packaging Type
WC1/8TO3/16X50	7.11	1.2	0.85	0.9	0.002	Plastic Reel
WC1/8TO3/16X200	6.5	1.2	3.5	3.8	0.004	Plastic Reel
WC3/16TO1/4X200	18.5	3.2	6.7	7	0.007	Plastic Reel
WC1/4TO5/16X200	23.7	4	11	11.5	0.008	Plastic Reel
WC5/16TO3/8X200	37.04	6.2	17	18	0.016	Plastic Reel

ROPES



Polypropylene Monofilament Rope

TPP31610

Length (Feet): 100'
 Thickness: 3/16"
 Maximum Load: 130 lb
 UPC: 810055041664
 MC-36 / V-1

TPP01450

Length (Feet): 50'
 Thickness: 1/4"
 Maximum Load: 225lb
 UPC: 810055041640
 MC-48 / V-1

TPP51650

Length (Feet): 50'
 Thickness: 5/16"
 Maximum Load: 342lb
 UPC: 810055041657
 MC-24 / V-1

TPP31650

Length (Feet): 50'
 Thickness: 3/16"
 Maximum Load: 440lb
 UPC: 810055043330
 MC-40 / V-5

TPP01410

Length (Feet): 100'
 Thickness: 1/4"
 Maximum Load: 700lb
 UPC: 810055043347
 MC-24 / V-6



Polypropylene Monofilament Rope - Roll

TR018L

Length (Feet): 1,640'
 Thickness: 1/8"
 Weight: 3.19kg - 7lb
 Maximum Load: 220lb
 UPC: 810055043354
 MC-2 / V-1

TR140L

Length (Feet): 1,900'
 Thickness: 1/4"
 Weight: 11.8kg - 26lb
 Maximum Load: 760lb
 UPC: 810055043378
 MC-1 / V-1

TR380L

Length (Feet): 800'
 Thickness: 3/8"
 Weight: 11.8kg - 26lb
 Maximum Load: 1,800lb
 UPC: 810055043392
 MC-1 / V-1

TR316L

Length (Feet): 1,800'
 Thickness: 3/16"
 Weight: 6.5kg - 14.3lb
 Maximum Load: 440lb
 UPC: 810055043361
 MC-2 / V-1

TR516L

Length (Feet): 1,200'
 Thickness: 5/16"
 Weight: 10kg - 22lb
 Maximum Load: 1,200lb
 UPC: 810055043385
 MC-1 / V-1

TR120L

Length (Feet): 500'
 Thickness: 1/2"
 Weight: 11.8kg - 26lb
 Maximum Load: 2,800lb
 UPC: 810055043408
 MC-1 / V-1



Orange and Black Polypropylene Monofilament Rope

TR139

Length (Feet): 50'
 Thickness: 3/8"
 Maximum Load: 1600 lb
 UPC: 810055043415
 MC-24 / V-6



Clothesline with Steel Cable

TR136

Length (Feet): 50'
 Thickness: 5/32"
 Maximum Load: 180 lb
 UPC: 810055043491
 MC-48 / V-8



White Polyester Rope

TR045

Length (Feet): 50'
 Thickness: 3/16"
 Maximum Load: 800 lb
 UPC: 810055043446
 MC-24 / V-6



TR046

Length (Feet): 100'
 Thickness: 3/16"
 Maximum Load: 800 lb
 UPC: 810055043453
 MC-24 / V-6



Nylon Clothesline Rope

TR40

Length (Feet): 50'
 Thickness: 3/16"
 Maximum Load: 900 lb
 UPC: 810055043422
 MC-36 / V-6



TR40100

Length (Feet): 100'
 Thickness: 3/16"
 Maximum Load: 900 lb
 UPC: 810055043439
 MC-36 / V-6



Synthetic Rope

TR125

Length (Feet): 50'
 Thickness: 5/32"
 Maximum Load: 350 lb
 UPC: 810055043484
 MC-48 / V-8



Synthetic Rope

TR112

Length (Feet): 100'
 Thickness: 3/16"
 Maximum Load: 100 lb
 UPC: 810055043507
 MC-24 / V-6



Mason Line Rope

TTN18

Length (Feet): 272'
 Thickness: #18 / 1.3mm
 Maximum Load: 34 lbs
 UPC: 810055041671
 MC-96 / V-6



TR30

Length (Feet): 325'
 Thickness: #15 / 1.3mm
 Maximum Load: 60 lb
 UPC: 810055043538
 MC-40 / V-10



Jute Rope

TR113

Length (Feet): 150'
 Thickness: 3/16"
 Maximum Load: 10 lb
 UPC: 810055043514
 MC-80 / V-8



TR114

Length (Feet): 190'
 Thickness: 3/16"
 Maximum Load: 10 lb
 UPC: 810055043521
 MC-80 / V-8



White Cotton Twine

TR133

Length (Feet): 325'
Thickness: #15 / 1.5mm
Maximum Load: 10 lb
UPC: 810055043545
MC-30 / V-10



Braided Polyester Rope

TR111

Length (Feet): 100'
Thickness: 1/8"
Maximum Load: 330 lb
UPC: 810055043460
MC-48 / V-8



Reflective Rope

TR100

Length (Feet): 50'
Thickness: 1/8"
Maximum Load: 250 lb
UPC: 810055043477
MC-80 / V-8

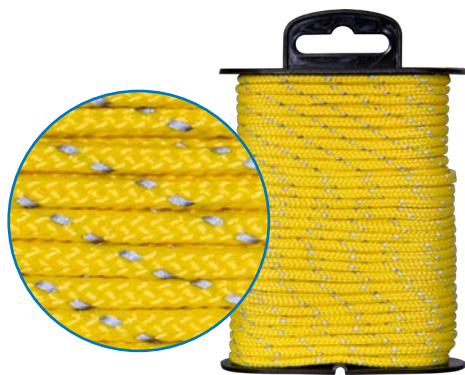

ROPES



HARDWARE

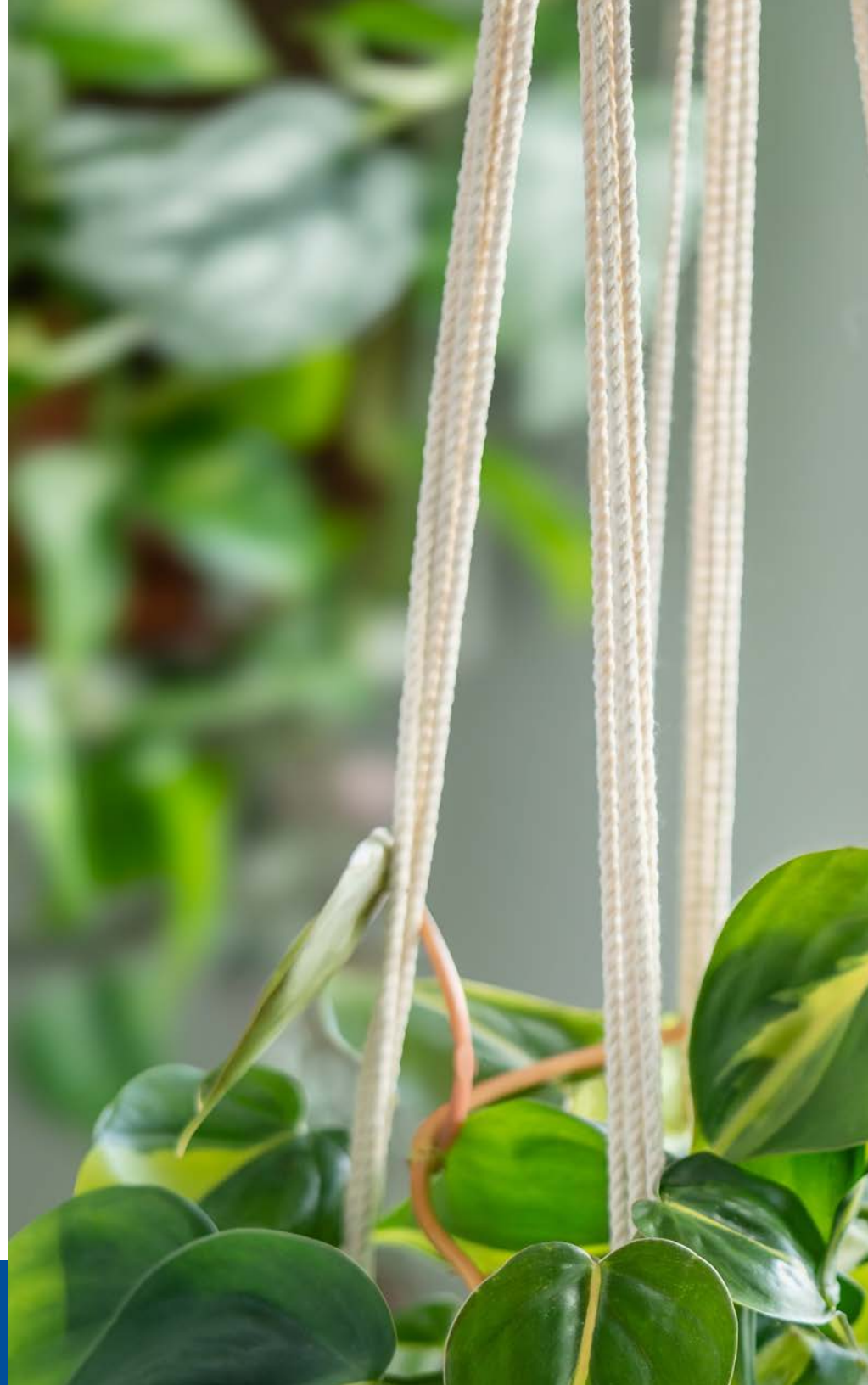

Single Wheel Pulley with Swivel Ring

SRS34

3/4"
Maximum Load: 25 lb
UPC: 810055042708
MC-12 / V-6

SRS114

1.25"
Maximum Load: 50 lb
UPC: 810055042715
MC-12 / V-6

SRS112

1.5"
Maximum Load: 50 lb
UPC: 810055043552
MC-12 / V-6

SRS2

2"
Maximum Load: 50 lb
UPC: 810055042722
MC-12 / V-6



Double Wheel Pulley with Swivel Ring

SRD34

3/4"
Maximum Load: 25 lb
UPC: 810055042777
MC-12 / V-6

SRD114

1.25"
Maximum Load: 50 lb
UPC: 810055042784
MC-12 / V-6

SRD112

1.5"
Maximum Load: 50 lb
UPC: 810055042791
MC-12 / V-6

SRD2

2"
Maximum Load: 50 lb
UPC: 810055042807
MC-12 / V-6



Tie-Down Ring with Plate

HRWP134

UPC: 810055042883
MC-12 / V-6



Hammock Hooks

TH22

UNITS: 2
With Plates
UPC: 871193004898
MC-48 / V-12



TH11

UNITS: 2
Lag hooks
UPC: 871193001293
MC-48 / V-12



Cup Hooks

CUPH12

1/2" / UNITS: 6
Maximum Load: 5 lb
UPC: 810055042814
MC-12 / V-12

CUPH34

3/4" / UNITS: 6
Maximum Load: 10 lb
UPC: 810055042821
MC-12 / V-12

CUPH1

1" / UNITS: 6
Maximum Load: 10 lb
UPC: 810055042838
MC-12 / V-12

CUPH114

1.25" / UNITS: 4
Maximum Load: 10 lb
UPC: 810055042845
MC-12 / V-12

CUPH112

1.5" / UNITS: 4
Maximum Load: 15 lb
UPC: 810055042852
MC-12 / V-12

CUPH134

1.75" / UNITS: 4
Maximum Load: 15 lb
UPC: 810055042869
MC-12 / V-12

CUPH2

2" / UNITS: 4
Maximum Load: 15 lb
UPC: 810055042876
MC-24 / V-12



Double Loop Chain

TDLC

0.08" x 200'
UPC: 810055040988
MC-1 / V-1

TDLC0.12X250

0.12" x 250'
UPC: 810055041275
MC-1 / V-1



Guillotine Chain

TSCH

0.035" x 100'
UPC: 810055041008
MC-1 / V-1



Double Jack Chain

TSTC

0.105" x 100'
UPC: 810055040995
MC-1 / V-1



Galvanized Chain

PCGC1/8X250

Galvanized Steel
Largo: 250'
Maximum Working Load:
170 kg / 375 lb
Minimum Breaking Load: 3.6 kn
NET WEIGHT: 22 kg
GROSS WEIGHT: 22.3 kg
UPC: 871193009800
MC-1 / V-1

PCGC1/4X141

Galvanized Steel
Largo: 141'
Maximum Working Load:
570 kg / 1250 lb
Minimum Breaking Load: 11.1 kn
NET WEIGHT: 46.15 kg
GROSS WEIGHT: 45.65 kg
UPC: 871193003396
MC-1 / V-1

PCGC3/8X64

Galvanized Steel
Largo: 64'
Maximum Working Load:
1200 kg / 2650 lb
Minimum Breaking Load: 23.6 kn
NET WEIGHT: 45 kg
GROSS WEIGHT: 45.5 kg
UPC: 871193003334
MC-1 / V-1

PCGC3/16X150

Largo: 150'
Galvanized Steel
Carga Máxima de Trabajo
340 kg / 750 lb
Minimum Breaking Load: 6.7 kn
NET WEIGHT: 27.45 kg
GROSS WEIGHT: 27.8 kg
UPC: 871193003754
MC-1 / V-1

PCGC5/16X92

Galvanized Steel
Largo: 92'
Maximum Working Load:
860 kg / 1900 lb
Minimum Breaking Load: 16.9 kn
NET WEIGHT: 44.2 kg
GROSS WEIGHT: 44.7 kg
UPC: 871193003341
MC-1 / V-1

PCGC1/2X37

Galvanized Steel
Largo: 37'
Maximum Working Load:
2040 kg / 4500 lb
Minimum Breaking Load: 40 kn
NET WEIGHT: 45.5 kg
GROSS WEIGHT: 46 kg
UPC: 871193003327
MC-1 / V-1



U-Bolt

UB516212

5/16" x 2-1/2"
Stainless Steel*
UPC: 810055042920
MC-100 / V-10

UB516312

5/16" x 3-1/2"
Steel
UPC: 810055042951
MC-100 / V-10

UB516414

5/16" x 4-1/4"
Steel
UPC: 810055043019
MC-100 / V-10

UB38358

3/8" x 3-5/8"
Steel
UPC: 810055042975
MC-100 / V-10

UB38612

3/8" x 6-1/2"
Steel
UPC: 810055043040
MC-80 / V-10

UB5163

5/16" x 3"
Steel
UPC: 810055042937
MC-100 / V-10

UB5164316

5/16" x 4-3/16"
Steel
UPC: 810055043033
MC-100 / V-10

UB51641116

5/16" x 4-11/16"
Steel
UPC: 810055043026
MC-10 / V-10

UB38418

3/8" x 4-1/8"
Steel
UPC: 810055042982
MC-100 / V-10

UB516314

5/16" x 3-1/4"
Steel
UPC: 810055042944
MC-100 / V-10

UB516334

5/16" x 3-3/4"
Steel
UPC: 810055043002
MC-100 / V-10

UB5165316

5/16" x 5-3/16"
Steel
UPC: 810055043033
MC-10 / V-10

UB38458

3/8" x 4-5/8"
Steel
UPC: 810055042999
MC-100 / V-10



Square U-Bolt

SQRB5163

5/16"x2"x3"
Steel
UPC: 810055043057
MC-100 / V-10

SQRB384

3/8" x 3-5/8" x 4"
Steel
UPC: 810055043088
MC-10 / V-10

SQRB383

3/8" x 3" x 4-1/2"
Steel
UPC: 810055043118
MC-10 / V-10

SQRB5165

5/16"x2"x5"
Steel
UPC: 810055043064
MC-100 / V-10

SQRB386

3/8" x 3-5/8" x 6"
Steel
UPC: 810055043095
MC-10 / V-10

SQRB385

3/8" x 3-5/8" x 5"
Steel
UPC: 810055043125
MC-10 / V-10

SQRB5167

5/16" x 3-5/8" x 7"
Steel
UPC: 810055043071
MC-100 / V-10

SQRB387

3/8" x 3-5/8" x 7"
Steel
UPC: 810055043101
MC-10 / V-10

SQRB3864

3/8" x 4" x 6"
Steel
UPC: 810055043132
MC-10 / V-10

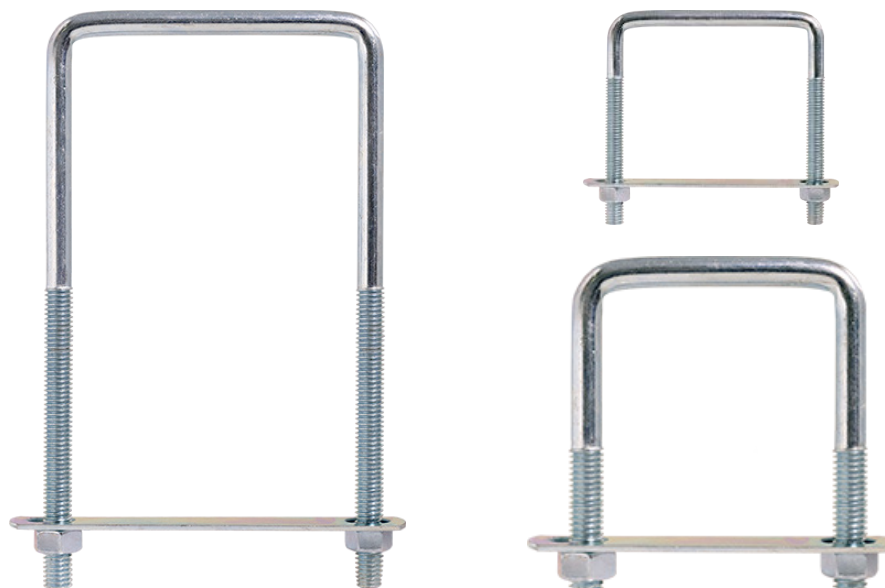

Storage Hook

TSH516

12" x 3-1/2" x 1/4"
 UPC: 871193008230
 MC-192 / V-6



Suspended Storage Hook

OSH516

5/16" x 6" x 1/4"
 UPC: 871193008261
 MC-192 / V-6



Beam Storage Hook

RSH516

5/16" x 3-3/4" x 1/4"
 UPC: 871193008254
 MC-288 / V-6



Utility Storage Hook

USH516

5/16" x 7" x 1/4"
 UPC: 871193008247
 MC-96 / V-6



Protective Tips - Plastic

White

LTP58W 5/8"
 UPC: 871193008841
 MC-192 / V-6

LTP34W 3/4"
 UPC: 871193008865
 MC-192 / V-6

LTP78W 7/8"
 UPC: 871193008889
 MC-96 / V-6

LTP1W 1"
 UPC: 871193008902
 MC-96 / V-6

Black

LTP58B 5/8"
 UPC: 871193008834
 MC-192 / V-6

LTP34B 3/4"
 UPC: 871193008858
 MC-192 / V-6

LTP78B 7/8"
 UPC: 871193008872
 MC-96 / V-6

LTP1B 1"
 UPC: 871193008896
 MC-96 / V-6



Protective Tips - Rubber

White

LTR58W 5/8"
 UPC: 871193008919
 MC-96 / V-6

LTR34W 3/4"
 UPC: 871193008933
 MC-96 / V-6

LTR78W 7/8"
 UPC: 871193008957
 MC-96 / V-6

LTR1W 1"
 UPC: 871193008971
 MC-48 / V-6

Black

LTR58B 5/8"
 UPC: 871193008834
 MC-96 / V-6

LTR34B 3/4"
 UPC: 871193008926
 MC-96 / V-6

LTR78B 7/8"
 UPC: 871193008964
 MC-96 / V-6

LTR1B 1"
 UPC: 871193008988
 MC-48 / V-6



Ladder Storage Hook

LSH516

5/16" x 7 3/4" x 1/4"
 UPC: 871193008223
 MC-96 / V-6



HARDWARE



HARDWARE

Nail-On Glides

Vinyl/ White
NG58 5/8"
 UPC: 871193009008
 MC-192 / V-12



NG34 3/4"
 UPC: 810055042647
 MC-192 / V-12



NG78 7/8"
 UPC: 871193009015
 MC-192 / V-12

Tap-On Glides

Plastic / White
PSP58 5/8"
 UPC: 871193009022
 MC-192 / V-12



PSP34 3/4"
 UPC: 871193009039
 MC-192 / V-12



PSP78 7/8"
 UPC: 871193009046
 MC-192 / V-12

Adjustable Closet Rods

ACR1830W
 18" x 30"
 White
 UPC: 810055042654
 MC-10 / V-5

ACR4872W
 48" x 72"
 White
 UPC: 810055042678
 MC-10 / V-5

ACR7296W
 72" x 96"
 White
 UPC: 810055042692
 MC-10 / V-5

ACR72120W
 72" x 120"
 White
 UPC: 810055042685
 MC-10 / V-5



ACR3048W
 30" x 48"
 White
 UPC: 810055042661
 MC-10 / V-5



ACR1830
 18" x 30"
 Galvanized Steel
 UPC: 871193008759
 MC-10 / V-5

ACR4872
 48" x 72"
 Galvanized Steel
 UPC: 871193008773
 MC-10 / V-5

ACR7296
 72" x 96"
 Galvanized Steel
 UPC: 871193008797
 MC-10 / V-5

ACR72120
 72" x 120"
 Galvanized Steel
 UPC: 871193008780
 MC-10 / V-5



ACR3048
 30" x 48"
 Galvanized Steel
 UPC: 871193008766
 MC-10 / V-5



Post Socket

PS1516W
 1 5/16
 White
 UPC: 871193008735
 MC-48 / V-6



PS1516CP
 1 5/16
 Chrome
 UPC: 871193008711
 MC-48 / V-6



PS1516SN
 1 5/16
 Satin Nickel
 UPC: 871193008728
 MC-48 / V-6



PPS138
 1 3/8
 Plastic
 UPC: 871193008742
 MC-48 / V-12



Clothe Hook

TCH018SSS

Stainless Steel

2"

UPC: 871193001545

MC-40 / V-5



Double Prong Robe Hook

RH2316

2 3/16"

UPC: 871193008384

MC-96 / V-12



Coat & Hat Hook

CHH300

3"

UPC: 871193008377

MC-96 / V-12



Type F Adjustable Shelf Bracket

TGHF02SS

Satin

82 × 23 × 65mm

UPC: 810055043965

MC-60 / V-5

**TGHF03SS**

Satin

98 × 26 × 75mm

UPC: 810055043989

MC-60 / V-5

TGHF02BF

Matte Black

82 × 23 × 65mm

UPC: 810055043972

MC-72 / V-6

**TGHF03BF**

Matte Black

98 × 26 × 75mm

UPC: 810055043996

MC-72 / V-6

Steel Shelf Bracket

SS14S

1/4" / UNITS: 6

Maximum Load: 25 lb

UPC: 810055043194

MC-24 / V-12



Perchas De Pared De Plástico

TWH01

28 mm

UPC: 871193007295

MC-120 / V-10

TWH03

48 mm

UPC: 871193007318

MC-120 / V-10

TWH02

38 mm

UPC: 871193007301

MC-120 / V-10



Plastic Shelf Brackets

SS14P

1/4" / UNITS: 6
 Maximum Load: 5 lb
 UPC: 810055043217
 MC-24 / V-12



Foldable L Shelf Brackets

FB12W

White
 Maximum Load: 160 lb
 UPC: 810055043170
 MC-5 / V-5



FB12Z

Steel
 Maximum Load: 160 lb
 UPC: 810055043187
 MC-5 / V-5



FB16W

White
 Maximum Load: 160 lb
 UPC: 810055043156
 MC-5 / V-5

FB16Z

Steel
 Maximum Load: 160 lb
 UPC: 810055043163
 MC-5 / V-5

Closet Rod and Shelf Bracket

HDSS10

10 3/4" x 11"
 UPC: 871193008704
 MC-12 / V-6



Shelf Brackets

White

USB34W 3" x 4"
 UPC: 871193008544
 MC-24 / V-12

USB45W 4" x 5"
 UPC: 871193008568
 MC-24 / V-12

USB56W 5" x 6"
 UPC: 871193008582
 MC-96 / V-12

USB68W 6" x 8"
 UPC: 871193008605
 MC-24 / V-12

USB810W 8" x 10"
 UPC: 871193008629
 MC-24 / V-12

USB1012W 10" x 12"
 UPC: 871193008643
 MC-24 / V-12

USB1214W 12" x 14"
 UPC: 871193008667
 MC-96 / V-12

Grey

USB34 3" x 4"
 UPC: 871193008537
 MC-24 / V-12

USB45 4" x 5"
 UPC: 871193008551
 MC-24 / V-12

USB56 5" x 6"
 UPC: 871193008575
 MC-24 / V-12

USB68 6" x 8"
 UPC: 871193008599
 MC-24 / V-12

USB810 8" x 10"
 UPC: 871193008612
 MC-24 / V-12

USB1012 10" x 12"
 UPC: 871193008636
 MC-24 / V-12

USB1214 12" x 14"
 UPC: 871193008650
 MC-96 / V-12



Heavy-Duty Shelf Bracket

HDSB12 12" x 8"
 UPC: 871193008674
 MC-12 / V-6

HDSB16 16" x 10"
 UPC: 871193008681
 MC-6 / V-6

HDSB20 20" x 13"
 UPC: 871193008698
 MC-12 / V-6



Terminal Cup

TBC01

Aluminum
2" x 1"
UPC: 810055040803
MC-100 / V-10

**TBC02**

Aluminum
1.5" x 1"
UPC: 810055040810
MC-100 / V-10

Corner Cup

TCBC01

Aluminum
2" x 1"
UPC: 810055040827
MC-100 / V-10

**TCBC02**

Aluminum
1.5" x 1"
UPC: 810055040834
MC-74 / V-10

Single Cup

TAPC01

Aluminum
1"
UPC: 810055040643
MC-350 / V-10

TAPC04

Aluminum
2.5"
UPC: 810055040674
MC-1 / V-10

TAPC02

Aluminum
1.5"
UPC: 810055040643
MC-350 / V-10

TAPC05

Aluminum
3"
UPC: 810055040681
MC-150 / V-10

TAPC03

Aluminum
2"
UPC: 810055040667
MC-300 / V-10



Single Cup

TALC01

Aluminum
2" x 1"
UPC: 810055040841
MC-200 / V-10

TALC02

Aluminum
1.5" x 1"
UPC: 810055040858
MC-100 / V-10

TALC03

Aluminum
2" x 1.25"
UPC: 810055040865
MC-100 / V-10



Tension Bar

TB01

9" x 8.25"
UPC: 810055040278
MC-500 / V-25

TB02

5/8" x 5"
UPC: 810055040285
MC-500 / V-25

TB03

5/8" x 6"
UPC: 810055040292
MC-25 / V-25



Tie Wire

TFTA01

Aluminum
9" x 8.25"
UPC: 810055040223
MC-1000 / V-100



End Cup

TARE01

Aluminum
1"
UPC: 810055040872
MC-350 / V-10

TARE02

Aluminum
1.25"
UPC: 810055040889
MC-170 / V-10



Barbed Wire or Concertina Arms

Sencilla

TBWA01

1.5" x 1.25"

UPC: 810055040230

MC-25 / V-25



TBWA02

2" x 1.25"

UPC: 810055040247

MC-25 / V-25

Doble

TDWA01

1.5" x 1.25"

UPC: 810055040254

MC-10 / V-10



TDWA02

2" x 1.25"

UPC: 810055040261

MC-10 / V-10

Gate Lock

TFL01

1.25" x 4"

UPC: 810055040308

MC-50 / V-10



Terminal Band

TBB01

1"

UPC: 810055040704

MC-360 / V-25

TBB04

2"

UPC: 810055040735

MC-250 / V-25

TBB02

1.25"

UPC: 810055040711

MC-350 / V-25

TBB05

3"

UPC: 810055040742

MC-200 / V-25

TBB03

1.5"

UPC: 810055040728

MC-400 / V-25



Tension Band

TTB01

1"

UPC: 810055040759

MC-360 / V-30

TTB04

2"

UPC: 810055040780

MC-250 / V-25

TTB02

1.25"

UPC: 810055040766

MC-280 / V-25

TTB05

3"

UPC: 810055040797

MC-180 / V-25

TTB03

1.5"

UPC: 810055040773

MC-300 / V-25



Gate Hinges

Female

TGH01

1"

UPC: 810055040452

MC-200 / V-10



TGH02

1.25"

UPC: 810055040469

MC-150 / V-10

Male

TPH01

1.5"

UPC: 810055040438

MC-125 / V-10



TPH02

2"

UPC: 810055040445

MC-90 / V-10

Gate Elbows

TAGC01

Aluminum
1"
UPC: 810055040537
MC-100 / V-20

**TGC01**

Steel
1.25"
UPC: 810055040544
MC-20 / V-5

**TGC02**

Steel
1.5"
UPC: 810055040551
MC-20 / V-5



Wall Male Hinge

TWGH

UPC: 810055042005
MC-100 / V-1



Boulevard Clamp

TBBC01

Steel
1.5" x 1"
UPC: 810055040568
MC-100 / V-25

TBBC03

Steel
2" x 1"
UPC: 810055040582
MC-100 / V-25

TBBC02

Steel
1.5" x 1.25"
UPC: 810055040575
MC-100 / V-25

TBBC04

Steel
2" x 1.25"
UPC: 810055040599
MC-50 / V-25



Galvanized Carriage Bolt

TCB01 1/4" x 3/4"

UPC: 810055040322
MC-2,000 / V-100

TCB07 3/8" x 1.25"

UPC: 810055040384
MC-600 / V-100

TCB02 5/16" x 1.25"

UPC: 810055040339
MC-1,000 / V-100

TCB08 3/8" x 1.5"

UPC: 810055040391
MC-500 / V-100

TCB03 5/16" x 1.5"

UPC: 810055040346
MC-900 / V-100

TCB09 3/8" x 2"

UPC: 810055040407
MC-500 / V-100

TCB04 5/16" x 2"

UPC: 810055040353
MC-800 / V-100

TCB10 3/8" x 2.5"

UPC: 810055040414
MC-400 / V-100

TCB05 5/16" x 2.5"

UPC: 810055040360
MC-700 / V-100

TCB11 3/8" x 35"

UPC: 810055040421
MC-300 / V-100

TCB06 5/16" x 3"

UPC: 810055040377
MC-600 / V-100



Terminal Clamp

TGBC01

Steel
1.5" x 1"
UPC: 810055040605
MC-50 / V-25

TGBC03

Steel
2" x 1"
UPC: 810055040629
MC-100 / V-25

TGBC02

Steel
1.5" x 1.25"
UPC: 810055040612
MC-100 / V-25

TGBC04

Steel
2" x 1.25"
UPC: 810055040636
MC-100 / V-25



Unions

TTRS01

1"

UPC: 810055040490
MC-80 / V-10**TTRS03**

1.5"

UPC: 810055040513
MC-45 / V-10**TTRS02**

1.25"

UPC: 810055040506
MC-50 / V-10**TTRS04**

2"

UPC: 810055040520
MC-30 / V-10

Lag Screw Male Hinge

TLSMH

5/8" X 4.5"

UPC: 810055042289
MC-100 / V-1**TJBMH**

5/8" X 4.5"

UPC: 810055042326
MC-100 / V-1

Galvanized Cane Bolt

TCBWL18

18" - 1/2"

UPC: 810055042029
MC-40 / V-1**TCBWL24**

24" - 5/8"

UPC: 810055042036
MC-20 / V-1

Removable Welding Bolt

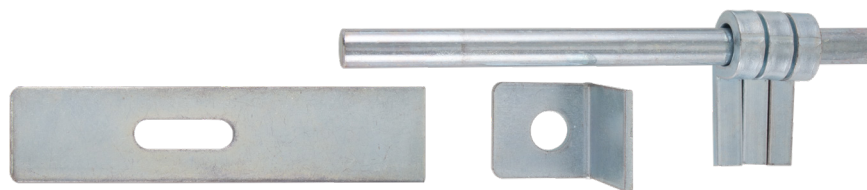
TWBBHDWLUPC: 810055041947
MC-37 / V-1

Wall Bracket

TWBWL

120 x 50 x 50mm

UPC: 810055042296
MC-60 / V-1

Galvanized Handrail Bracket

TSHBFGalvanized Steel
110 x 90 x 70mmUPC: 810055042142
MC-50 / V-1

Galvanized Ceiling Bracket

TCBWLUPC: 810055042340
MC-30 / V-1Galvanized Steel
165 x 65 x 60mm

Galvanized Weld Tabs

TWTWL01

Galvanized Steel
1" x 1.75" x 3.75" / 5mm
UPC: 810055042159
MC-150 / V-25

**TWTWL04**

Galvanized Steel
3.75" x 1.5" / 3mm
UPC: 810055042180
MC-150 / V-25

**TWTWL07**

Galvanizado
2.5" x 1.5" / 3mm
UPC: 810055042210
MC-100 / V-25

**TWTWL02**

Galvanized Steel
1.5" x 1.5" / 5mm
UPC: 810055042166
MC-200 / V-25

**TWTWL05**

Galvanized Steel
2.5" x 2.5" x 1.5" / 5mm
UPC: 810055042197
MC-80 / V-20

**TWTWL03**

Galvanized Steel
3.75" x 1.5" x 1.5" / 5mm
UPC: 810055042173
MC-80 / V-25

**TWTWL06**

Galvanized Steel
2.5" x 2.5" x 1.5" / 3mm
UPC: 810055042203
MC-120 / V-20

**TWTWL08**

Galvanizado
1.5" x 1.5" x 1.3" / 3mm
UPC: 810055042302
MC-300 / V-25



Round Welding Hinge

TRHWL01

3"
UPC: 810055042043
MC-42 / V-2



Galvanized Welding Hinge

THG01

Galvanized Steel
4" x 2" 4mm
UPC: 810055041954
MC-40 / V-2



Barrel Hinge With Plate

TBHPWL01

5"
UPC: 810055042050
MC-21 / V-1

**TBHPWL02**

7"
UPC: 810055042067
MC-6 / V-1

Galvanized Gate Handle

TGHWL
Galvanized Steel
176 x 20 4.5mm
UPC: 810055042319
MC-50 / V-1



Galvanized Wheel Box

Galvanized Steel
TWBWL04
4"
UPC: 810055042227
MC-24 / V-1



TWBWL06
6"
UPC: 810055042234
MC-16 / V-1

Guide Rollers

Rubber
TRGRWL01 3"
UPC: 810055042074
MC-20 / V-2



TRGRWL02 4"
UPC: 810055042081
MC-16 / V-2

TRGRWL03 6"
UPC: 810055042098
MC-10 / V-2

Galvanized Welding Barrel Bolt

TBBWL 3" x 5.5"
Galvanized Steel
UPC: 810055042012
MC-80 / V-1



Wheels

Chrome Steel
TWCPSWL04
4"
UPC: 810055042265
MC-8 / V-2



TWCPSWL06
6"
UPC: 810055042258
MC-4 / V-2

Nylon
TNGRWL01 3"
UPC: 810055042104
MC-20 / V-2



TNGRWL02 4"
UPC: 810055042111
MC-20 / V-2

TNGRWL03 6"
UPC: 810055042128
MC-10 / V-2

Track Rollers

TDTRWL
1.8"x 4.3" x 4.6"
UPC: 810055042272
MC-30 / V-1



Cast Iron
TWCIWL04
4"
UPC: 810055042241
MC-18 / V-2



Nylon
TNGRWL04
1.6"x 2.4"
UPC: 810055042135
MC-50 / V-1



Plastic Caps

Black

TPCB1X1

1"x 1"

UPC: 810055041824

MC-500 / V-100

TPCB1X1-1/2

1"x 2"

UPC: 810055041831

MC-500 / V-100

TPCB1-1/2X1-1/2

1.5"x 1.5"

UPC: 810055041848

MC-800 / V-100

TPCB2X2

2"x 2"

UPC: 810055041855

MC-400 / V-50

TPCB2-1/2X2-1/12

2.5"x 2.5"

UPC: 810055041862

MC-250 / V-50

TPCB3X3

3"

UPC: 810055041879

MC-200 / V-50



White

TPCW1X1

1"x 1"

UPC: 810055041886

MC-1,000 / V-100

TPCW1X1-1/2

1"x 2"

UPC: 810055041893

MC-500 / V-100

TPCW1-1/2X1-1/2

1.5"x 1.5"

UPC: 810055041909

MC-800 / V-100

TPCW2X2

2"x 2"

UPC: 810055041916

MC-400 / V-50

TPCW2-1/2X2-1/12

2.5"x 2.5"

UPC: 810055041923

MC-250 / V-50

TPCW3X3

3"

UPC: 810055041930

MC-200 / V-50



Stainless Steel Mailboxes

TMB02SS
 Stainless Steel
 UPC: 871193002474
 MC-5 / V-1



TMB03SS
 Stainless Steel
 UPC: 871193002498
 MC-5 / V-1



TMB203G+SS
 Stainless Steel + Galvanized
 UPC: 871193009381
 MC-1 / V-1



Plastic Mailbox

TMB04B
 Black
 UPC: 871193007974
 MC-4 / V-1



TMB04W
 White
 UPC: 871193007981
 MC-4 / V-1



US Mail Box

TMB01
 Black
 UPC: 871193002535
 MC-4 / V-1



TMB01W
 White
 UPC: 871193007950
 MC-4 / V-1

TMB01S
 Grey
 UPC: 871193007967
 MC-4 / V-1



Mailbox Lock

TT1816-NP
 18mm x 16mm
 UPC: 871193004256
 MC-120 / V-10



Stainless Steel Mailbox Base

TMBB48SS

48"
Stainless Steel
UPC: 871193008025
MC-5 / V-1

TMBB60SS

60"
Stainless Steel
UPC: 871193008032
MC-5 / V-1

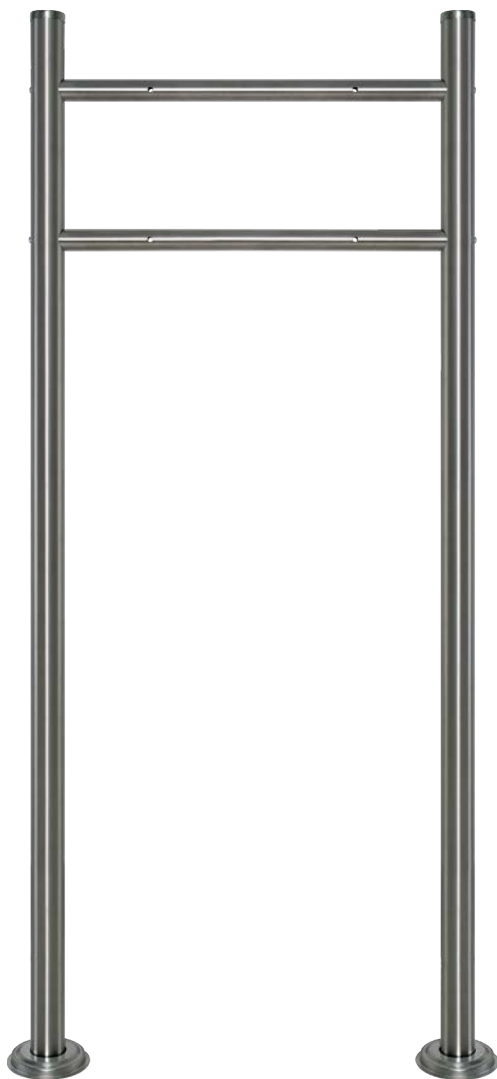

US Mailbox Base

TMBB58

58"
UPC: 871193008018
MC-10 / V-1



Combination Key Boxes

CPK01

Portable Installation
UPC: 871193002399
MC-30 / V-1



TCWK01

Wall Installation
UPC: 871193002412
MC-30 / V-1



Security Cash Box

TSCB01

Includes 2 Keys
9.84" x 7.87" x 3.15"
UPC: 871193002450
MC-10 / V-1



T-Locks

Provides reliable solutions for those seeking basic and accessible security across a variety of applications. Featuring elegant finishes such as Satin Stainless Steel and Matte Black, this series stands out for its quality and versatility, offering options that balance style and practicality. Backed by a 10-year warranty, T-Locks is the ideal choice for those who value a robust product that outperforms other options in its category without exceeding the budget.



Deadbolt

SINGLE CYLINDER

L301US32D
UPC: 871193000593
MC-24 / V-6

L301US11
UPC: 871193006007
MC-24 / V-6

L301US5
UPC: 871193000609
MC-24 / V-6

L301US3
UPC: 871193006830
MC-24 / V-6

L301US514
UPC: 810055044115
MC-24 / V-6



DOUBLE CYLINDER

L312US32D
UPC: 871193000623
MC-24 / V-6

L312US11
UPC: 810055041350
MC-24 / V-6

L312US5
UPC: 871193000630
MC-24 / V-6

L312US3
UPC: 871193002429
MC-24 / V-6

L312US514
UPC: 810055044122
MC-24 / V-6



Low Profile Deadbolt

SINGLE CYLINDER

E301US32D
UPC: 810055040940
MC-24 / V-6

E301US514
UPC: 810055040964
MC-24 / V-6



DOUBLE CYLINDER

E312US32D
UPC: 810055040957
MC-24 / V-6

E312US514
UPC: 810055040971
MC-24 / V-6



Knobset

KEYED ENTRY

T871US32D
 UPC: 871193000531
 MC-24 / V-6

T871US11
 UPC: 871193005987
 MC-24 / V-6

T871US5
 UPC: 871193000548
 MC-24 / V-6

T871US3
 UPC: 871193002641
 MC-24 / V-6



PRIVACY

T872US32D
 UPC: 871193000562
 MC-24 / V-6

T872US11
 UPC: 871193005994
 MC-24 / V-6

T872US5
 UPC: 871193000579
 MC-24 / V-6

T872US3
 UPC: 871193002665
 MC-24 / V-6



Low Profile Leverset

KEYED ENTRY

T631LUUS15
 UPC: 810055040902
 MC-24 / V-6

T361LUUS514
 UPC: 810055040926
 MC-24 / V-6



PRIVACY

T632LUUS15
 UPC: 810055040919
 MC-24 / V-6

T632LUUS514
 UPC: 810055040933
 MC-24 / V-6



Leverset

KEYED ENTRY

- **T431US32D**
UPC: 871193001477
MC-24 / V-6



- **T431US11**
UPC: 810055041367
MC-24 / V-6

- **T431US5**
UPC: 871193006373
MC-24 / V-6

**PRIVACY**

- **T432US32D**
UPC: 871193001484
MC-24 / V-6



- **T432US11**
UPC: 810055041374
MC-24 / V-6

- **T432US5**
UPC: 871193006397
MC-24 / V-6



Leverset

KEYED ENTRY

- **T431BAUS15**
UPC: 810055041688
MC-24 / V-6



- **T431BAUS514**
UPC: 810055043774
MC-24 / V-6

**PRIVACY**

- **T432BAUS15**
UPC: 810055041695
MC-24 / V-6



- **T432BAUS514**
UPC: 871193005994
MC-24 / V-6



Knobset Combo

SINGLE CYLINDER

T871L301US32D

UPC: 871193000654

MC-12 / V-6

T871L301US5

UPC: 871193000661

MC-12 / V-6

T871L301US3

UPC: 871193005291

MC-12 / V-6



DOUBLE CYLINDER

T871L312US32D

UPC: 871193000685

MC-12 / V-6

T871L312US5

UPC: 871193000692

MC-12 / V-6

T871L312US3

UPC: 871193002924

MC-12 / V-6



Low Profile Leverset Combo

SINGLE CYLINDER

T631E301LUUS15

UPC: 810055043835

MC-24 / V-6

T631E301LUUS514

UPC: 810055043859

MC-24 / V-6



DOUBLE CYLINDER

T631E312LUUS15

UPC: 810055043842

MC-24 / V-6

T631E312LUUS514

UPC: 810055043866

MC-24 / V-6



Leverset Combo

SINGLE CYLINDER

- **T431L301US32D**
UPC: 871193002191
MC-24 / V-6

**DOUBLE CYLINDER**

- **T431L312US32D**
UPC: 871193002207
MC-24 / V-6



Leverset Combo

SINGLE CYLINDER

- **T431/L301BAUS15**
UPC: 810055043798
MC-24 / V-6



- **T431/L301BAUS514**
UPC: 810055043811
MC-24 / V-6

DOUBLE CYLINDER

- **T431/L312BAUS15**
UPC: 810055043804
MC-24 / V-6



- **T431/L312BAUS514**
UPC: 810055043828
MC-24 / V-6

Handlesets

SINGLE CYLINDER

TD810US32D
 UPC: 871193001835
 MC-6 / V-1



TD810US11
 UPC: 871193006014
 MC-6 / V-1

TD810US5
 UPC: 871193001842
 MC-6 / V-1



DOUBLE CYLINDER

TD811US32D
 UPC: 871193001866
 MC-6 / V-1



TD811US11
 UPC: 810055041398
 MC-6 / V-1

TD811US5
 UPC: 871193001873
 MC-6 / V-1



Heavy-Duty Padlock

LS20

UPC: 871193000807
MC-72 / V-6

LS25

UPC: 871193000814
MC-72 / V-6

LS30

UPC: 871193000821
MC-60 / V-6

LS40

UPC: 871193000838
MC-60 / V-6

LS50

UPC: 871193000845
MC-60 / V-6

LS50L

Long Shackle
UPC: 871193000869
MC-48 / V-6

LS60

UPC: 871193000852
MC-60 / V-6

LS75

UPC: 871193002948
MC-48 / V-6

LS50KA2

UPC: 871193000876
MC-36 / V-6

LS50KA3

UPC: 871193000883
MC-24 / V-6

LS50KA4

UPC: 871193000890
MC-18 / V-6

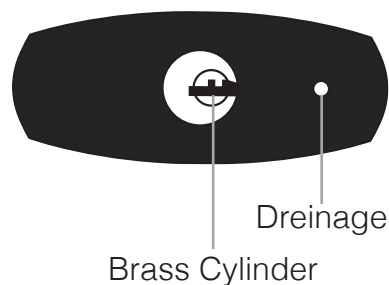
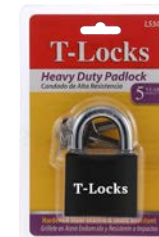

Iron Hinges

Stainless Steel Finish

Non-Removable Bar

T300300SSF

UPC: 871193004317

MC-60 / V-6

T350300SSF

UPC: 871193004348

MC-24 / V-6

T400300SSF

UPC: 871193004379

MC-24 / V-6



Antique Brass Finish

Non-Removable Bar

T350300ABF

UPC: 871193004355

MC-24 / V-6

T400300ABF

UPC: 871193004386

MC-24 / V-6



Oil-Rubbed Finish

Non-Removable Bar

T350300RBF

UPC: 871193004362

MC-100 / V-6

T400300RBF

UPC: 871193004393

MC-40 / V-6

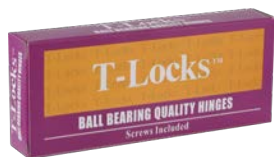

Welding Hinges

T300200WL

UPC: 871193006564

MC-50 / V-10

T350250WL

UPC: 871193006571

MC-50 / V-10

T400250WL

UPC: 871193006588

MC-50 / V-10



Floor-Mounted Door Stop at an Angle

TFS201SC

Solid Brass
Includes Screw
UPC: 871193004270
MC-120 / V-10



Heavy Duty T-Hinge

THT25-ZP

10"
2 pieces per package.
UPC: 871193005901
MC-20 / V-5



THT30-ZP

12"
2 pieces per package.
UPC: 871193005918
MC-10 / V-5



TOLEDO®

LOCKS • PADLOCKS • HARDWARE

TOLEDO & Co. DISTRIBUTION

Points of distribution in the Caribbean, North and Central America.



Distribution Centers:

- Puerto Rico
- Dominican Republic
- Panama
- Boston MA, EUA
- Miami FL, EUA

Incorporated Territories:

- Abaco
- Anguilla
- Antigua
- Aruba
- Bahamas
- Barbados
- Belize
- Bermuda
- Bonaire
- Cayman Islands
- Curaçao
- Dominica
- Dominican Republic
- El Salvador
- Freeport
- Grenada
- Guyana
- Honduras
- Jamaica
- Mexico
- Montserrat
- Nicaragua
- Panama
- Puerto Rico
- Saba
- Saint Barthelemy
- Saint Croix
- Saint Eustatius
- Saint John
- Saint Lucia
- Saint Martin
- Saint Thomas
- Saint Vincent and the Grenadines
- Tortola
- Trinidad and Tobago
- Turks and Caicos Islands
- United States
- Virgin Gorda

Prospect Territories:

- Argentina
- Bolivia
- Colombia
- Fiji
- Guadeloupe
- Guam
- Martinique
- Peru
- Uruguay

TOLEDO PRODUCTS BAYS AVAILABLE AT: Hardware stores, department stores and chains.



TOLEDO PRODUCTS BAYS AVAILABLE AT: Hardware stores, department stores and chains.



PLANOGRAM SOLUTIONS DESIGNED FOR EFFICIENCY AND GROWTH



ON-SITE BRANDING SOLUTIONS: EVENT & PROMOTIONAL SETUPS



T-LOCKS PRODUCTS BAYS AVAILABLE AT: Hardware stores, department stores and chains.



Toledo & Co. LLC
Po Box 915
Dorado PR
00646-0915

Carr. #2 km 30.7
Parque Industrial Espinosa
Vega Alta, PR 00692

TEL. 787.807.3738
FAX. 787.807.3767
TOLL FREE 1.866.714.6073

www.toledolocks.com
info@toledolocks.com
[@toledolockspr](https://www.instagram.com/toledolockspr)



Revised January 2025

